

User Manual

AC Charger

AC007E-01 / AC007E-01 L1



All Rights Reserved

All Rights Reserved

No part of this document can be reproduced in any form or by any means without the prior written permission of Sungrow Power Supply Co., Ltd (hereinafter "SUNGROW").

Trademarks

SUNGROW and other Sungrow trademarks used in this manual are owned by SUNGROW.

All other trademarks or registered trademarks mentioned in this manual are owned by their respective owners.

Software Licenses

- It is prohibited to use data contained in firmware or software developed by SUNGROW, in part or in full, for commercial purposes by any means.
- It is prohibited to perform reverse engineering, cracking, or any other operations that compromise the original program design of the software developed by SUNGROW.

Privacy Protection

- Information contained in this manual is the private property of Sungrow Power Supply Co., Ltd. No part of this manual may be transmitted in any form without the prior written permission of Sunlight Power Co., Ltd. Internal reproduction is allowed only for product evaluation or other appropriate purposes.
- We declare that the network account and password data stored in the equipment system are only used for remote control and monitoring of the equipment and will not be transmitted to any third-party data platform without the user's permission.
- At our EV charger, we take the privacy of our customers seriously. We only collect charging information in accordance with applicable privacy laws and regulations.

Disposal

After the service life of the charger ends, please dispose of it in accordance with the applicable electrical waste disposal act at the installation location. It can also be returned to Sungrow Power Supply Co., Ltd., but the relevant expenses shall be borne by your party.

About This Manual

The manual mainly contains product information, as well as guidelines for installation, operation, and maintenance.

Target Group

This manual is intended for qualified technicians who are responsible for the installation, operation, and maintenance of the charger, and end users who need to check charger parameters.

A qualified technician is required to meet the following requirements:

- Knowledge of electronics, electricity, and machinery, and be familiar with electrical and mechanical schematic diagrams.
- Training in the installation and commissioning of electrical equipment.
- Be able to quickly respond to hazards or emergencies that occur during installation and commissioning.
- Be familiar with local standards and relevant safety regulations of electrical systems.
- Read this manual thoroughly and understand the safety instructions related to operations.

EMC

In some cases, even if the equipment is in accordance with the standard emission limits, it can have an impact in certain application areas (some sensitive equipment is placed in the same location; the equipment is installed close to a radio or TV receiver), and the operator is obliged to take appropriate action to correct this situation.

How to Use This Manual

Please read this manual carefully before using the product and keep it properly in a place for easy access.

All contents, pictures, marks, and symbols in this manual are owned by SUNGROW. No part of this document may be reprinted by the non-internal staff of SUNGROW without written authorization.

Contents of this manual may be periodically updated or revised, and the actual product purchased shall prevail. Users can obtain the latest manual from support.sungrowpower.com or sales channels.

Symbols

This manual contains important safety instructions, which are highlighted with the following symbols, to ensure personal and property safety during usage, or to help optimize the product performance efficiently.

 **DANGER**

Indicates high-risk potential hazards that, if not avoided, may lead to death or serious injury.

 **WARNING**

Indicates moderate-risk potential hazards that, if not avoided, may lead to death or serious injury.

 **CAUTION**

Indicates low-risk potential hazards that, if not avoided, may lead to minor or moderate injury.

NOTICE

Indicates potential risks that, if not avoided, may lead to device malfunctions or financial losses.



“NOTE” indicates additional information, emphasized contents, or tips that may be helpful, e.g., to help you solve problems or save time.

Contents

All Rights Reserved	I
About This Manual	II
1 Safe Introductions	1
2 Introduction	3
2.1 Introduction	3
2.2 Model and Nameplate	3
2.3 Appearance and Dimensions	4
2.4 LED Signals	4
2.5 Electrical Connection Ports	5
2.6 System Topology	5
3 Installation	7
3.1 Installation Requirements	7
3.2 Unpacking and Inspection	8
3.3 Installation Tools	10
3.4 Electrical Connection	11
3.4.1 Circuit Diagram	11
3.4.2 AC Cable Connection	11
3.4.3 RS485 Communication Connection	14
3.5 Wall-Mounted Installation	16
3.6 Pole-Mounted Installation	20
3.6.1 Foundation Installation	20
3.6.2 Pole Installation	21
4 Inspection before Commissioning	25
5 Troubleshooting	26
6 iEnergyCharge App	31
6.1 Download and Installation	31
6.2 Sign-up and Log in	31
6.3 Add a Charger	32
6.4 Charging View	35
6.4.1 Start/Stop Charging	36

6.4.2 Scheduled Charging	36
6.4.3 Device Settings	36
6.5 Account	39
6.5.1 Charging Bills	39
6.5.2 Scheduled Charging	40
6.5.3 Customer Service	41
6.5.4 Network Settings	42
6.5.5 Firmware Management	43
6.5.6 Device Connection	44
6.5.7 Charge Cards	44
6.5.8 Settings	45
7 Appendix	47
7.1 Technical Data	47
7.2 Quality Assurance	49
7.3 Contact Information	50

1 Safe Introductions

This manual contains important instructions for SUNGROW charger that shall be followed during installation, operation, and maintenance. Please review all warnings and notices before installing and using the charger.

WARNING

Do not install or use the charger near flammable, explosive, harsh or combustible materials, chemicals, or vapors.

WARNING

Turn off the power supply at the circuit breaker before installing or cleaning the charger.

NOTICE

Use the charger only within the operation steps and parameters specified in this manual.

NOTICE

Never spray water or any other liquid directly onto the charger body or the charging connector. Store the charger in the connector socket to prevent unnecessary damage.

NOTICE

Do not attempt to disassemble, repair, tamper with or modify the charger. Contact SUNGROW for any repair or modification.

NOTICE

Do not use the charger if it is defective, appears cracked, frayed, broken or otherwise damaged, or fails to operate. Please contact SUNGROW in time.

NOTICE

Be careful when transporting the charger. Do not subject it to strong force or impact or pull, twist, tangle, drag, or step on the charger to prevent damage to it or any components.

NOTICE

Do not touch the end terminal of the charger with any part of your body or metal objects.

NOTICE

Use of charger may affect or impair the operation of any medical or implantable electronic devices, such as implantable cardiac pacemakers or implantable cardioverter defibrillator. Please check with your electronic device manufacturer concerning the effects of the charger on such electronic devices before using the charger.

2 Introduction

2.1 Introduction

The **AC007E-01 / AC007E-01 L1** charger (hereinafter "charger") is used for AC charging of electric vehicles (EV/PHEV) and can be either wall-mounted or pole-mounted, with the following advantages:

Ease of Use

EV drivers can start and stop charging via RFID card or App. When the vehicle is fully charged, the charging will stop. The charger also supports plug&play charging, which means the charging starts automatically as soon as the charging connector is plugged into the vehicle.

Smart and Easy Management

In addition to the LED lights on the charger that indicate charging status, EV drivers can visualize and control the charging session remotely via .

Sustainability

With an IP65 rating, the charger is water and dust proof, allowing for outdoor use and maintenance.

2.2 Model and Nameplate

The charger comes in two versions for different use cases:



- AC007E-01 (hereinafter referred as "the advanced version")
- AC007E-01 L1 (hereinafter referred as "the standard version")

Model

Nameplate

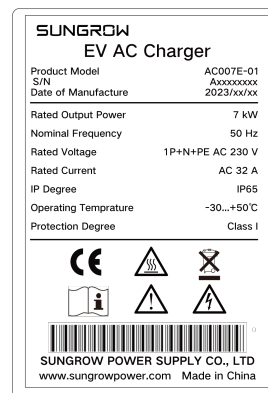
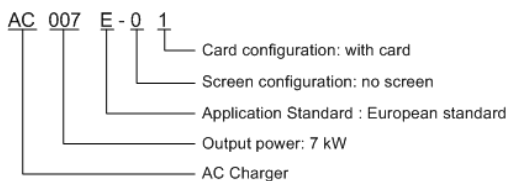

2.3 Appearance and Dimensions

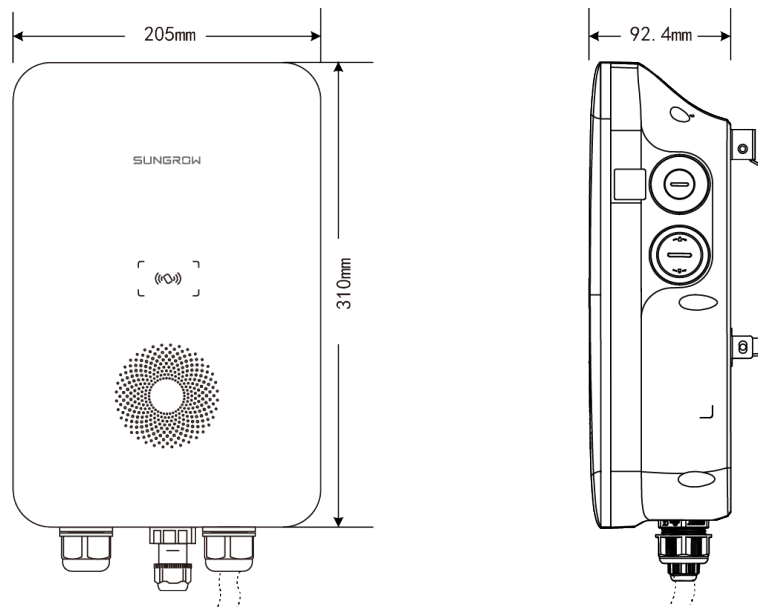

figure 2-1 Appearance and dimensions

2.4 LED Signals

table 2-1 LED Signals

Indicator	Indicator
Standby	Blue indicator flashes slowly, on for 1 s and off for 4s ; circulating
Charging	Blue indicator breathes, on for 1s and off for 1s; circulating
Charging stops	Blue indicator is steady on
Ready to charge	Blue indicator flashes quickly, on for 0.5s and off for 0.5s; circulating
Charging reservation	Blue indicator is on for 3s and red indicator is on for 3s
Power-on self-test	Blue indicator is on for 1s and red indicator is on for 1s
Charger software upgrading	Blue indicator flashes quickly
Swiping Card	Blue light is on for 5 times with an interval of 0.2s

2.5 Electrical Connection Ports

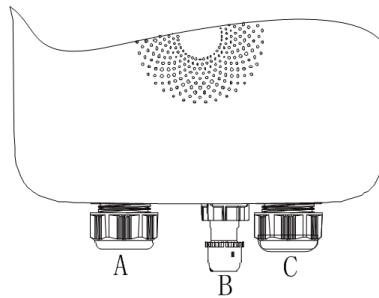

figure 2-2 Port Diagram

table 2-2 Label Explanation

Label	Explanation
A	AC input (AC connection)
B	RS485 external communication
C	Charging cable output (Charging cable connection)

2.6 System Topology

Stand-alone EV Charger

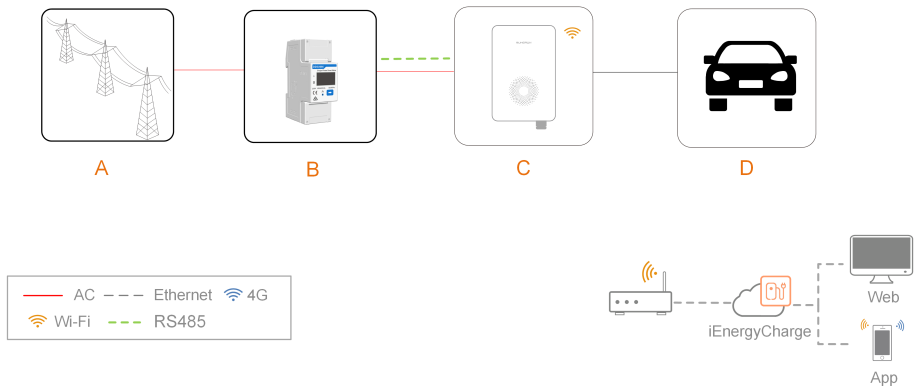

figure 2-3 System topology diagram of EV charger

Position	Description	Note
A	Utility grid	TT, TN-C, TN-S, TN-C-S.
B	Smart Energy Meter	Optional (DDSU666).
C	Charger	AC007E-01 L1
D	Electric vehicle	-

3 Installation

⚠ WARNING

Respect all local standards and requirements during mechanical installation.

⚠ CAUTION

Any damage or malfunction with the charger caused by negligence or improper use will not be eligible for service and replacement under the warranty.

3.1 Installation Requirements

Location Requirements

Select an optimal mounting location for safe operation, long service life and expected performance.

- The charger with protection rating IP65 can be installed both indoors and outdoors.
- The charger should be installed at a place where the LED signals can be easily seen, and is convenient for electrical connection, operation, and maintenance.

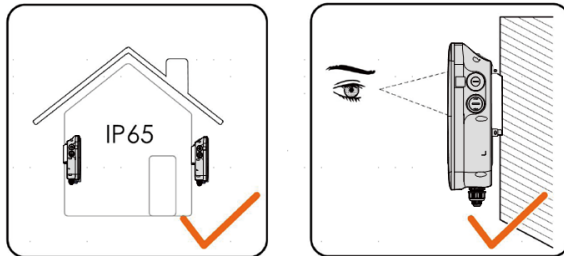

Environment Requirements

- There must be no flammable hazards or ignition risks.
- The mounting location must be inaccessible to children.
- The ambient temperature and relative humidity must meet the following requirements.

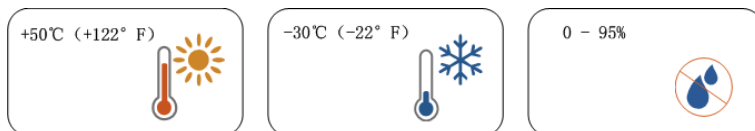

- Avoid exposure to direct sunlight, rainwater and snow.
- The charger should be well-ventilated for good air circulation.
- The mounting location must be away from living area. The charger will emit noises during operation that might be perceived as disturbing.

Carrier Requirements

The mounting structure where the charger is installed must comply with local/national standards and guidelines.

Ensure that the installation surface is solid enough to bear 4.5 times the weight of the charger and is suitable for the dimensions of the inverter.

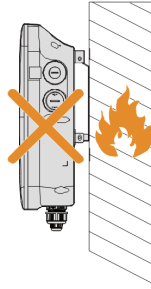

Angle Requirements

- Install the charger vertically.
- Do not install the charger horizontally, tilted or upside down.
- Do not install the charger on a tilted surface.

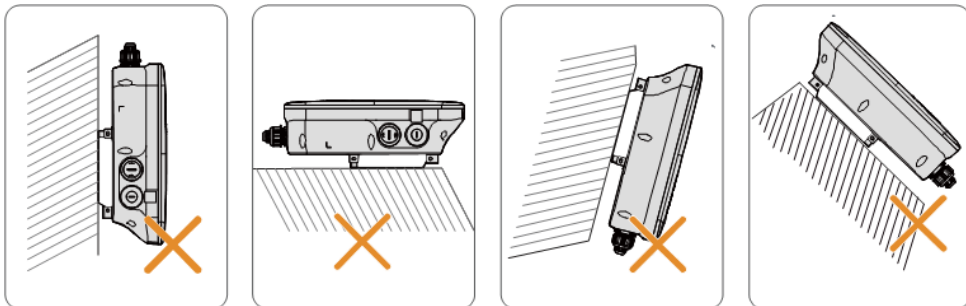

3.2 Unpacking and Inspection



After receiving the product, check whether the appearance and structural parts of the device are damaged, and check whether the packing list is consistent with the actual ordered product. If there are problems, do not install the device and contact your distributor first. If the problem persists, contact SUNGROW in time.

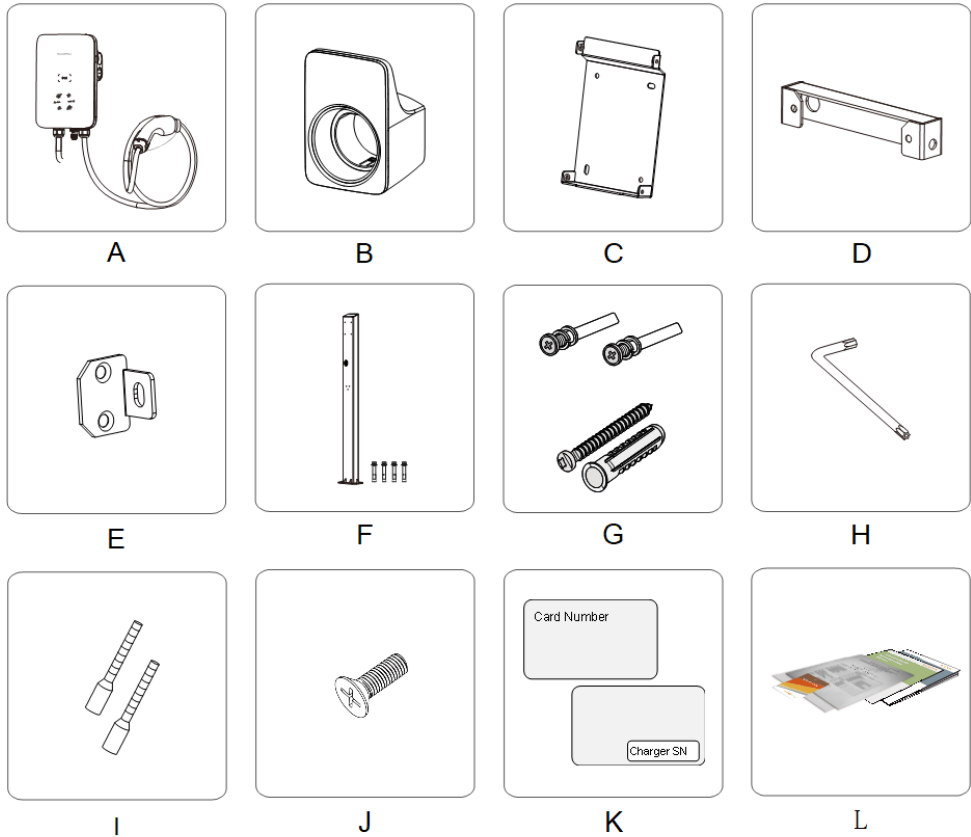

table 3-1 Label Descriptions

Item	Name	Quantity
A	AC-Charger	1
B	Charging cable bracket	1
C	Backplate	1
D	Upper mounting plate	1
E	Lower mounting plate	2
F	Mounting pole (optional)	1 (not included in scope of delivery)
G	Combination screw and expansion screw	4, 7 (wall-mounted); 11, 0 (pole-mounted)
H	L-shaped spanner	1
I	Wire end ferrule	1~2
J	Countersunk screw	6
K	RFID card	2
L	Quick Installation Guide, Warranty Card, and Certificate of Conformity	1, 1, 1



The scope of delivery does not include the optional mounting pole (F), this item must be ordered separately.

3.3 Installation Tools

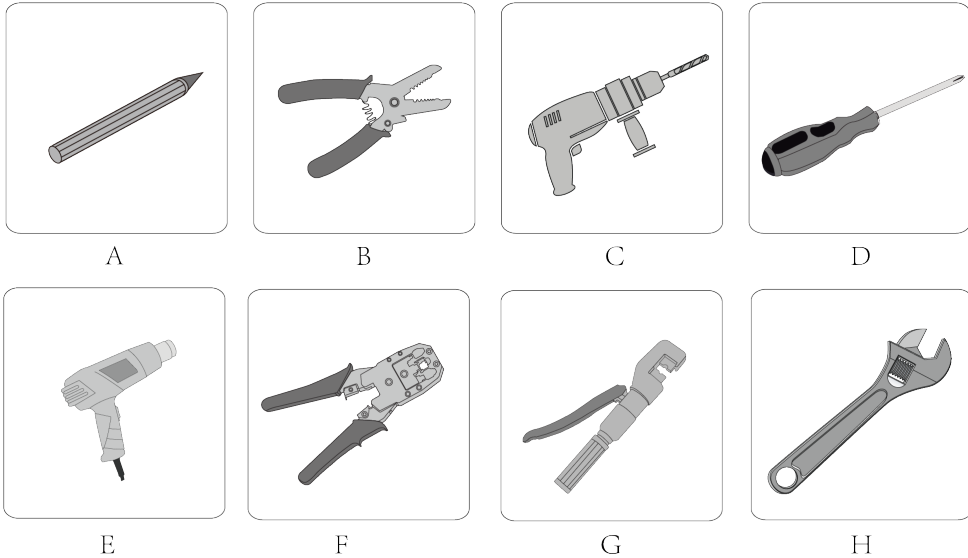

table 3-2 Label Descriptions

Item	Name	Specification
A	Marker	-
B	Wire stripper	-
C	Hammer drill	Ø6, Ø12
D	Screwdriver	M3, M4
E	Heat gun	-
F	RJ45 crimping tool	-
G	Hydraulic plier	2.5-6 mm ²
H	Adjustable spanner	-

3.4 Electrical Connection

3.4.1 Circuit Diagram

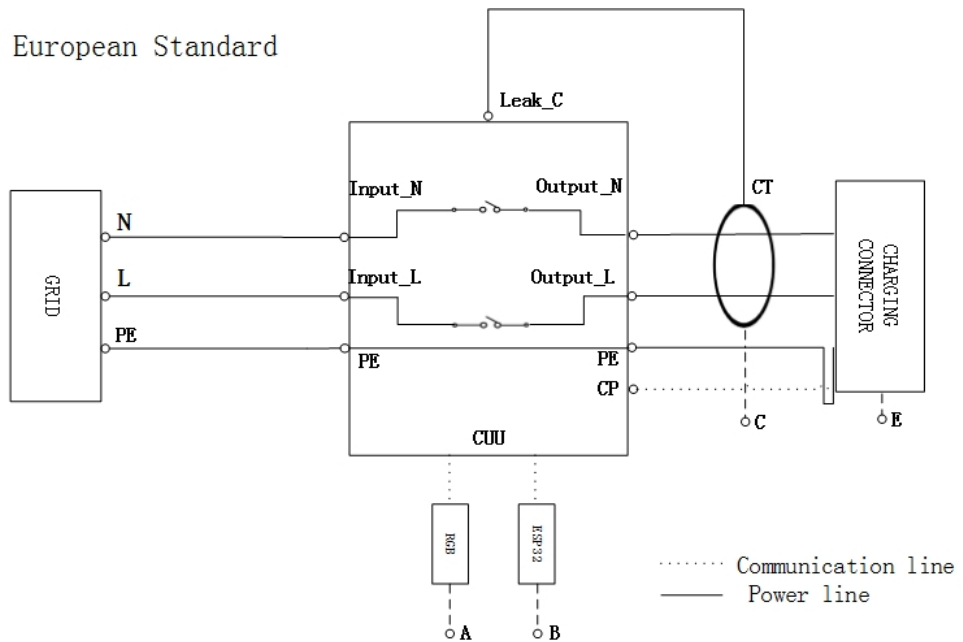

figure 3-1 Circuit diagram(European)

table 3-3 Label Descriptions

Label	Description
A	The LED lights that indicates the status of the charger
B	ESP32 module for Wi-Fi communication
C	CT for leakage current detection
E	Charging connector Type 2

NOTICE

The charger already integrates a DC residual-current device (RCD) with a rated residual current of 6 mA. However, the charger also requires a type A RCD of 30 mA to operate. Each charger in the system must be individually connected to the utility grid through an RCD and a miniature circuit breaker.

3.4.2 AC Cable Connection

AC Cable Requirement

Cable cross-section: $3 \times 6 \text{ mm}^2$

Step 1 Place the charger face-down on a clean and flat surface.

Step 2 Loosen the screws that secure the back cover plate. (M3 screws, torque: $0.5 \pm 0.1 \text{ N}\cdot\text{m}$)

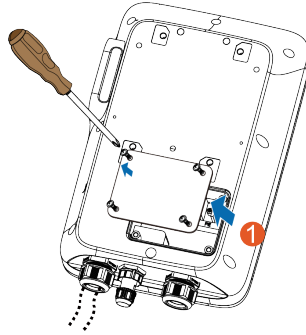

Step 3 Plug the cable into the port of the power supply which is at the leftmost.

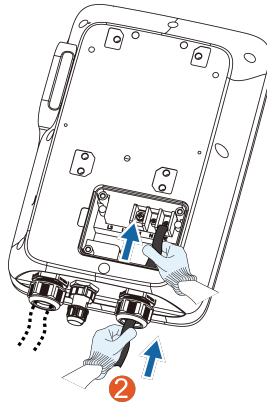

Step 4 Adjust the cable to a suitable length, and strip off the insulation of the cable to prepare for cable connection terminals.

- 1 Strip off the insulation from the end of each wire.
- 2 Insert the copper core of the stripped end of the wire into the copper lug.
- 3 Tighten the copper lug using a hydraulic plier.
- 4 Select a heat-shrink tubing that matches the diameter of the wire.

The length of the tubing should be about 2 mm longer than the length of the copper lug's wire tube.

- 5 Place the heat-shrink tubing on the copper lug until it completely covers the copper lug's wire hole.
- 6 Activate heat-shrink tubing using a heat gun.

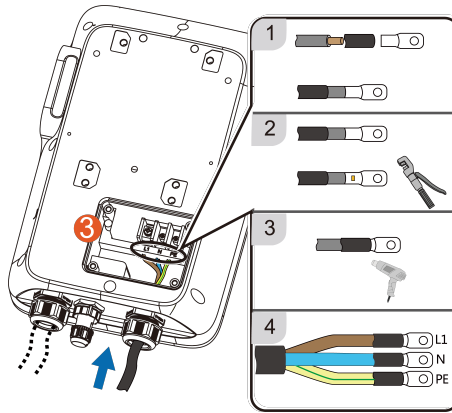

Color	Terminal
Brown	L1
Blue	N
Yellow-green	PE

Step 5 Connect each crimped terminal (OT2.5-5) and tighten them using a screwdriver. (Torque: 3 ± 0.2 N·m)

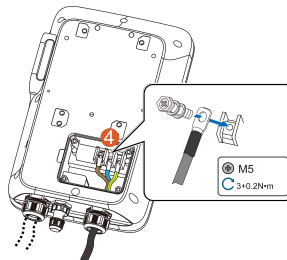

Step 6 Put the back cover plate back in place and tighten the screws to secure it.

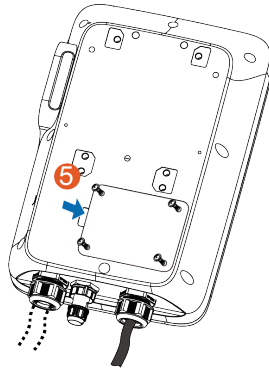

-- End

3.4.3 RS485 Communication Connection



In the stand-alone usage application scenario, you may connect an RS485 cable to the meter to enable ALM function.



For the Residential Hybrid + AC Charging Solution, the RS485 communication connection is needed to connect the AC Charger to SUNGROW's 1-phase inverter (SHRS).

Step 1 Crimp both ends of the Ethernet cable using a crimping tool.



You will receive one of the following two RJ45 terminal components, please refer to the actual product you receive.

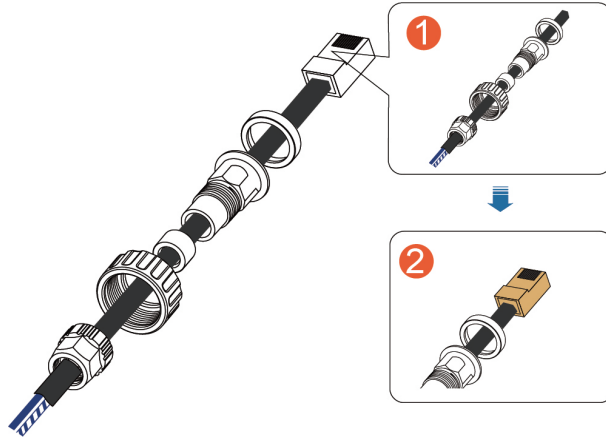

figure 3-2 RJ45 screw connector(A)

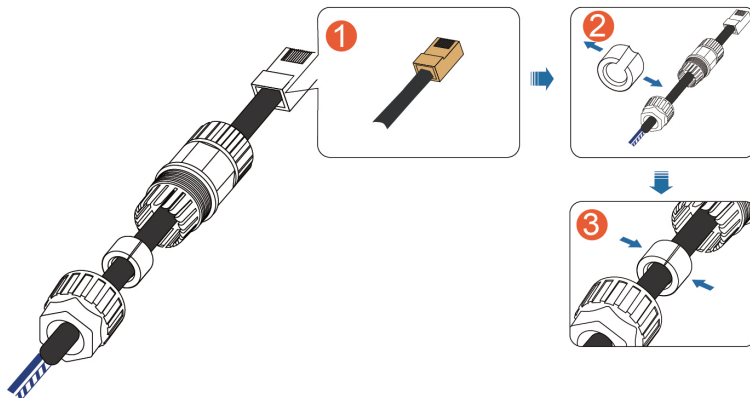
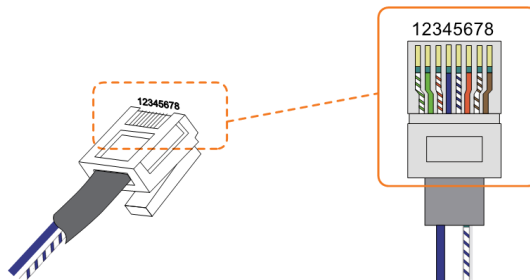

figure 3-3 RJ45 screw connector(B)



Ensure that the blue wire and the blue-white wire is correctly crimped.
The blue wire (PIN 4) connects to 485B, and the blue-white wire (PIN 5) connects to 485A.



Step 2 Insert the RJ45 connector to the RJ45 jack.

Step 3 Install seals for the Ethernet cable in sequence.

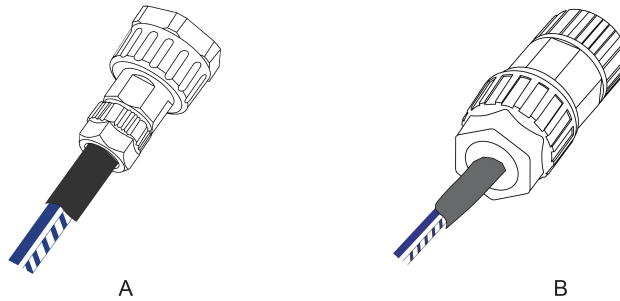

Ensure that the cable is secured.

Step 4 Connect the charger to a Smart Energy Meter or a SUNGROW Hybrid inverter.

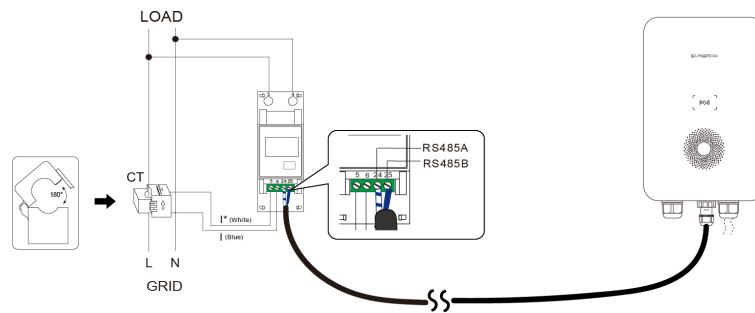

figure 3-4 Connect to a Smart Energy Meter

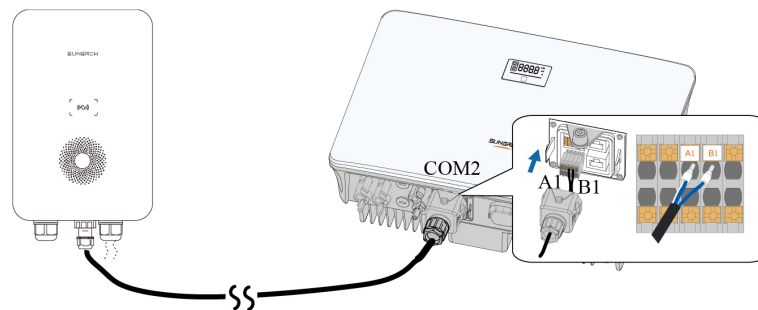

figure 3-5 Connect to an inverter(SHRS)

-- End

3.5 Wall-Mounted Installation

Install the charger on the wall using the provided wall-mounting bracket and expansion screw sets.



- Installation height of the charger from ground: 1.1m recommended
- The load-bearing capacity of the installation carrier must be at least 4.5 times the weight of the charger.

Step 1 Install the backplate.

- 1 Hold the backplate in the desired position on the wall and mark the positions of the drill holes.

NOTICE

Before drilling the hole for the backplate, locate and avoid water pipes and electrical wires in the wall.

- 2 Drill holes at the marked positions using a hammer drill. (Diameter: 6 mm; depth: 45 mm)
- 3 Insert the dowel into the holes.
- 4 Place the backplate on the wall and tighten the screws using a screwdriver to secure the backplate.

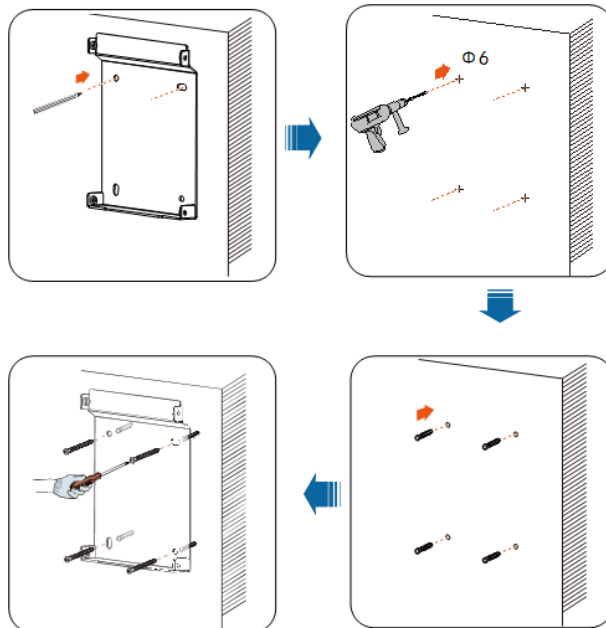

Step 2 Install the charging cable bracket.

- 1 Hold the charging cable bracket in the desired position on the wall and mark the positions of the drill holes.
- 2 Drill holes at the marked positions using a hammer drill.
- 3 Insert the dowel into the hole.
- 4 Place the charging cable bracket on the wall, and tighten the screws to secure the charging cable bracket using a screwdriver.

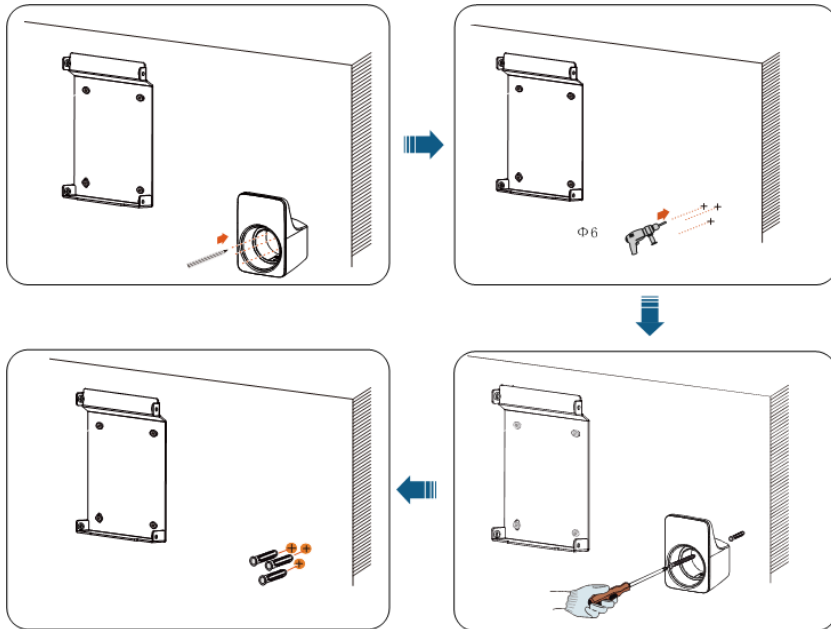

It is recommended that the charging cable bracket be positioned at the lower right side of the charger, about 20 cm away from the charger. The distance shall be adjusted according to the actual situation.

Step 3 Mount the charger.

- 1 Secure the upper mounting plate and the lower mounting plate on the back of the charger using a screwdriver. (Torque: $1.2 \pm 0.1 \text{ N}\cdot\text{m}$)

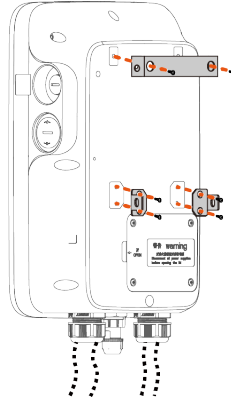

- 2 Hang the charger onto the backplate.

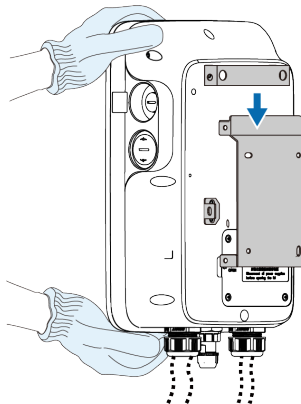

- 3 Secure the upper and lower mounting plates to the backplate with screws. (Torque: $1.2 \pm 0.1 \text{ N}\cdot\text{m}$).

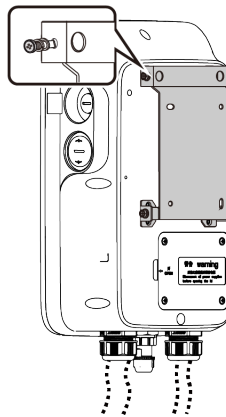

-- End



Installation height of the connector socket from ground: 1.1m recommended, from charger: 0.5m recommended

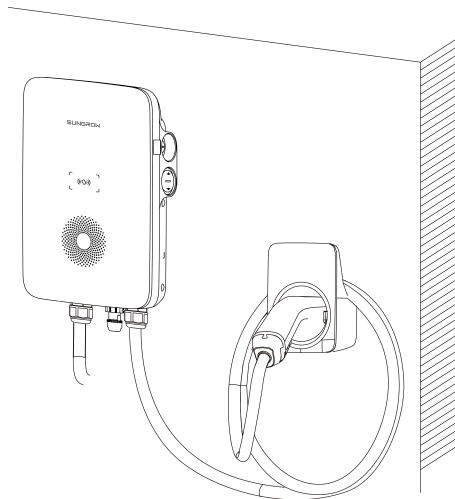

figure 3-6 Wall-mounted charger

3.6 Pole-Mounted Installation



It is recommended to install the pole on a solid support surface (such as concrete or tarmac). If conditions do not permit, please install the foundation first, and then install the mounting pole.

3.6.1 Foundation Installation

The base should be 100 mm above the ground, and the exterior dimensions of the front, back, left, and right side columns should be greater than 100 mm. Ensure that there are openings for cables.

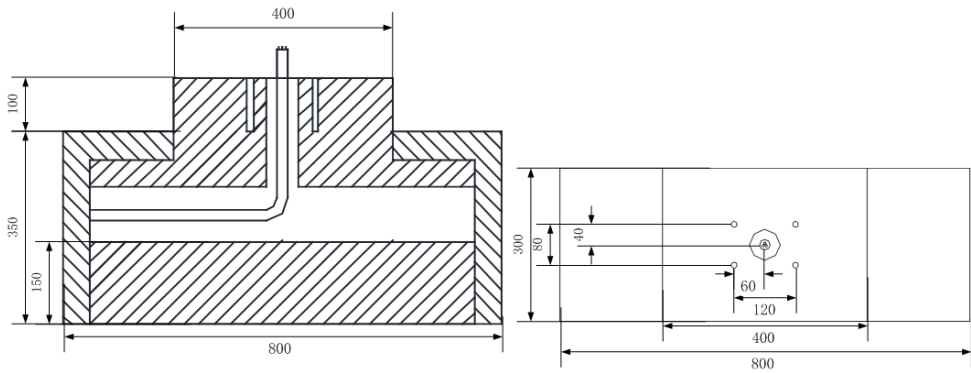
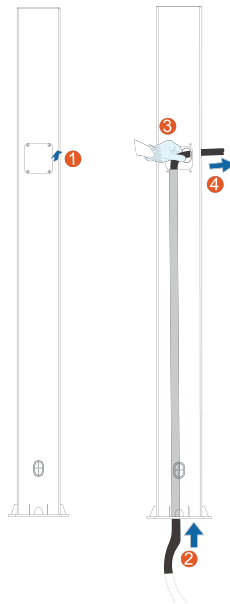

figure 3-7 Front view and top view (unit: mm)

3.6.2 Pole Installation

Step 1 Connect the AC cable.

- 1 Remove the cover plate on the back of the pole using a cross screwdriver.
- 2 Lead the AC cable through the bottom into the pole.
- 3 Grab the AC cable when it reaches the cover plate and take out the end of the cable from the AC cable outlet.
- 4 Pull the cable out to an appropriate length and close the cover plate.



Step 2 Mount the charger.

- 1 Place the pole on a solid and flat surface, and mark the positions of the drill holes.
- 2 Drill holes at the marked positions using a hammer drill. (Diameter: 12 mm; depth: 70 mm)
- 3 Insert the dowel into the holes.
- 4 Tighten the expansion screw using a screwdriver.

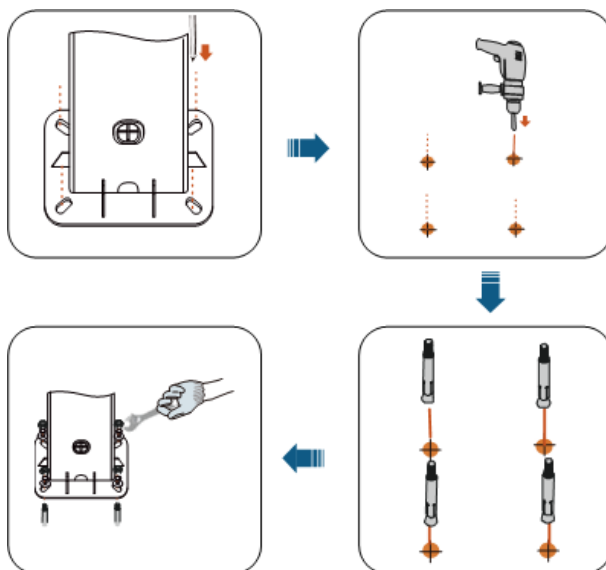

- 5 Check whether the pole is firmly installed.

Step 3 Install the backplate and the charging cable bracket.

- 1 Align the holes in the backplate with the holes drilled in the pole, and secure the backplate to the pole with screws.
- 2 Align the holes in the bracket with the holes drilled in the pole, and secure the bracket to the pole with screws.
- 3 Check whether the backplate and the charging cable bracket are firmly installed.

Step 4 Install the upper mounting plate and lower mounting plate.

- 1 Place the charger face-down on a clean and flat surface, and secure the upper and lower mounting plates to the pole using a screwdriver.
- 2 Ensure that the upper mounting plate and the lower mounting plate are firmly installed.
- 3 Hang the charger onto the backplate.
- 4 Secure the upper and lower mounting plates to the backplate.
- 5 Check whether the charger is correctly installed on the pole.

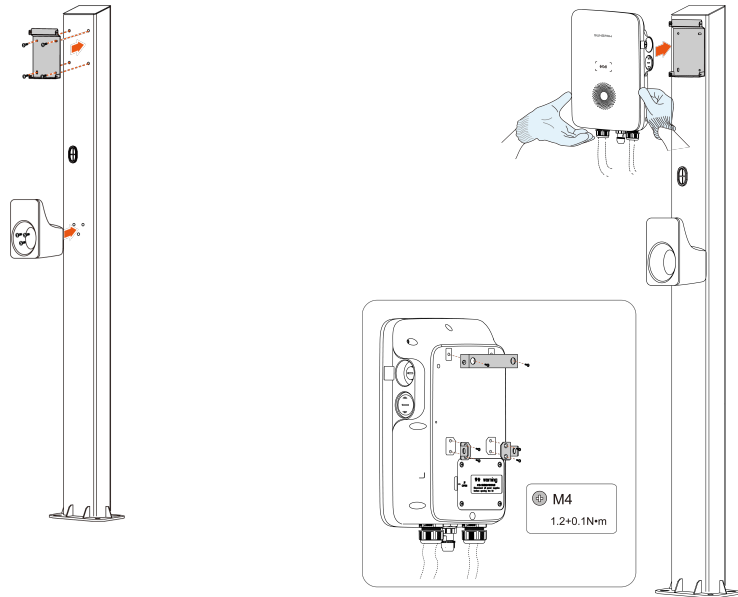

-- End

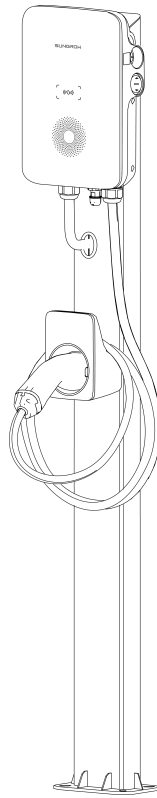

figure 3-8 Pole-mounted charger

4 Inspection before Commissioning

table 4-1 Requirements before commissioning

Item	Description
Location	The charger is correctly mounted at a place that is convenient for operation and maintenance.
Charger	The charger is firmly and securely installed.
Cable	Cables are correctly and firmly connected, and are adequately protected from damage.
Current leakage protection	The AC input's current leakage protection switch is reasonable.
Clearance	The charger has sufficient cooling space and there is no other stuff or components are left on the top of the charger.

Step 1 Ensure that all requirements are met before commissioning.

Step 2 Turn on the current leakage protection switch of the AC input.

Step 3 Power on the charger.

The blue LED blinks slowly which indicates the charger is in standby mode.

- - End

5 Troubleshooting

table 5-1 Fault Resolution

Problem	Possible Cause	Solution
Overvoltage	1 The grid voltage at the input end of the charger exceeds 276V .	<p>Usually, the charger will be re-connected to the grid once the voltage falls inside the range of 251V~209V for 2 minutes. If the problem occurs repeatedly:</p> <ol style="list-style-type: none"> 1 Measure the actual grid voltage, and contact local power company for solutions if the grid voltage is above 265V. 2 Contact Sungrow Customer Service if the problem persists.
	2 The grid voltage is still above 265V after overvoltage.	
Undervoltage	1 The grid voltage at the input end of the charger is below 184V .	<p>Usually, the charger will be re-connected to the grid once the voltage falls inside the range of 251V~209V for 2 minutes. If the problem occurs repeatedly:</p> <ol style="list-style-type: none"> 1 Measure the actual grid voltage, and contact the local power company for solutions if the grid voltage is below 196V. 2 Check if the AC cables are firmly connected. 3 Contact Sungrow Customer Service if the problem persists.
	2 The grid voltage is still below 196V after undervoltage.	

Problem	Possible Cause	Solution
Overfrequency	<ol style="list-style-type: none"> 1 The mains AC frequency exceeds 63 Hz. 2 The grid frequency is still above 61 Hz after overfrequency. 	<p>Usually, the charger will be re-connected to the grid once the grid returns to normal. If the problem occurs repeatedly:</p> <ol style="list-style-type: none"> 1 Measure the actual grid frequency, and contact the local power company for solutions if the grid frequency is above 61 Hz. 2 Contact Sungrow Customer Service if the problem persists.
Underfrequency	<ol style="list-style-type: none"> 1 The mains AC frequency is below 47 Hz. 2 The grid frequency is still below 49 Hz after underfrequency. 	<p>Usually, the charger will be re-connected to the grid once the grid returns to normal. If the problem occurs repeatedly:</p> <ol style="list-style-type: none"> 1 Measure the actual grid frequency, and contact the local power company for solutions if the grid frequency is below 49 Hz. 2 Contact Sungrow Customer Service if the problem persists.
Leakage current	The DC leakage current is above 6 mA	
EV Overcurrent	<p>Output current is above over-current point.</p> <p>Mark : Adjust the over-current value following the actual current, below 20 A, over-current value is actual current + 2 A; Above 20 A, over-current value is 1.1 times the actual current; If there is no define current, which is 1.1 time the max. current.</p>	<ol style="list-style-type: none"> 1 Stop charging and pull out the charging connector. When the charger returns to normal, try charge again. If the problem occurs repeatedly, contact the EV manufacturer's customer service. 2 Stop charging and pull out the charging connector. Contact Sungrow Customer Service if the problem persists.

Problem	Possible Cause	Solution	
Charger	Relay adhesion	The relay is stuck and cannot be disconnected.	Restart the charger and try again. If the problem occurs repeatedly, contact Sungrow Customer Service.
	Leakage current detection circuit failure	<ol style="list-style-type: none"> 1 The CT terminal has bad connection or the CT is malfunctioning. 2 The RCD circuit is abnormal. 	
	Relay overtemperature	The temperature of the main relay is too high. It might be a hardware problem.	
	CP failure	Abnormal CP circuit on the main board	
Wiring	Input terminal overtemperature	<ol style="list-style-type: none"> 1 The input terminal is loosely connected which causes bad connection. 2 The cable's current-carrying capacity does not meet the requirements. 	<ol style="list-style-type: none"> 1 Ensure that the AC cable is tightly connected, that the cable used meets requirements, and L and N wires are correctly connected. 2 Contact Sungrow Customer Service if the problem persists.
	Reverse polarity	L and N wires are connected reversely.	
	Meter communication abnormal	No communication between the meter and the charger for 1 minute.	
CT fault	The bus current measured by the CT is smaller than the actual output current of the charger. Something abnormal with the CT.	Replace the CT, or turn off the load balancing function.	

table 5-2 LED Signals that indicates abnormal conditions

Charger Status	LED Signals
Leakage current	Red light is on for 0.5s, off for 0.5s, and flashes 4 times, and then off for 3s. Cyclic
CP failure	Red light is on for 0.5s, off for 0.5s, and flashes 5 times, and then off for 3s. Cyclic
Overcurrent	Red light is on for 0.5s, off for 0.5s, and flashes 6 times, and then off for 3s. Cyclic
Relay adhesion	Red light is on for 0.5s, off for 0.5s, and flashes 7 times, and then off for 3s. Cyclic
Leakage current circuit abnormal	Red light is on for 0.5s, off for 0.5s, and flashes 8 times, and then off for 3s. Cyclic
Input terminal over-temperature	Red light is on for 0.5s, off for 0.5s, and flashes 9 times, and then off for 3s. Cyclic
Relay over-heat	Red light is on for 0.5s, off for 0.5s, and flashes 10 times, and then off for 3s. Cyclic
Undervoltage	Red light is on for 0.5s, off for 0.5s, and flashes 11 times, and then off for 3s. Cyclic
Overvoltage	Red light is on for 0.5s, off for 0.5s, and flashes 12 times, and then off for 3s. Cyclic
Over-frequency	Red light is on for 0.5s, off for 0.5s, and flashes 13 times, and then off for 3s. Cyclic
Under-frequency	Red light is on for 0.5s, off for 0.5s, and flashes 14 times, and then off for 3s. Cyclic
Security chip failure	Red light is on for 0.5s, off for 0.5s, and flashes 16 times, and then off for 3s. Cyclic
CT abnormal	Red light is on for 0.5s, off for 0.5s, and flashes 17 times, and then off for 3s. Cyclic
ALM Meter communication abnormal	Red light is on for 0.5s, off for 0.5s, and flashes 18 times, and then off for 3s. Cyclic
Alarms (ground alarm, disassembly alarm, reverse phase alarm and etc.)	Red light is on



If the above faults cannot be removed, please contact Sungrow.

6 iEnergyCharge App

iEnergyCharge App is a tool that allows users to operate and manage their EV chargers. Users can complete account settings and charger configuration, manage charge cards, operate the charger, and reach customer service on the App.



Depending on the version of iEnergyCharge you are using, the user interface might be slightly different.

6.1 Download and Installation

Operating System:

- Android 6.0 or later
- iOS 11 or later

Option 1

Download the App from the below application stores and install it on your device:

- Google Play
- App Store

Option 2

Scan the QR code below, and download and install the App by following the onscreen instructions.



6.2 Sign-up and Log in

Step 1 Open the iEnergyCharge App, and tap **Sign up**.

Step 2 Enter an email address, and tap **Next**.

Step 3 Find the verification code sent by the system in your email inbox. Then, go back to the App, enter the verification code, and tap **Next**.

Step 4 Enter a password, and the sign-up process is now completed. You will then go to the App's **Home** screen.

-- End

6.3 Add a Charger

To add a charger to your account on the iEnergyCharge App for operation and management, you need to set up a reliable network connection between the devices first.

Requirements:

- The charger is powered on;
- Stable WLAN networks are available.



- The charger's WLAN can only be on for 15 minutes. If the network is off, you can restart the charger and connect again.
- To avoid potential interference, it is recommended to enable airplane mode on your mobile device when connecting to the charger's WLAN.

Step 1 Tap **Add device** on the **Home** screen.

Step 2 Scan the QR code on the side of the charger, and then, in the "Add device" dialog, tap **Establish Connection**.

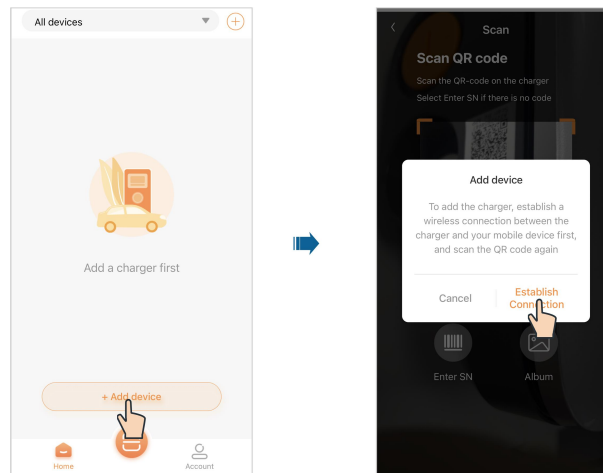

Step 3 Go to WLAN settings on your mobile device, and connect to the charger's WLAN. The charger's WLAN is named as its S/N, and the password is **"admin123"** or **no password** required.

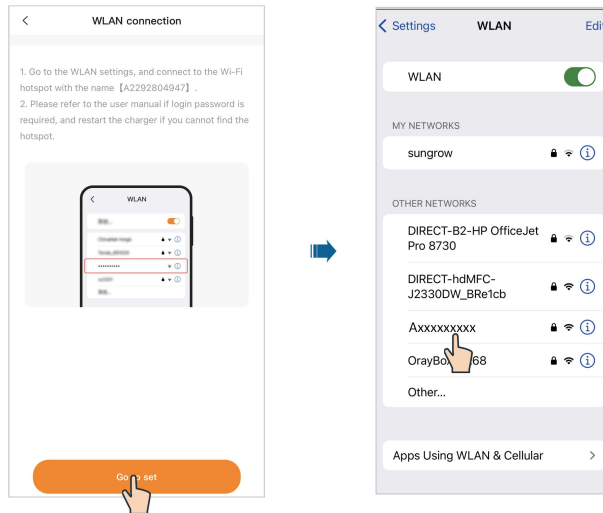

Step 4 Once connected successfully, go back to the App and enter the login password, which should be **"SGC666"**, or **"the 4-digit PIN code"** on the back of the charge card. Then, tap **Log in**.

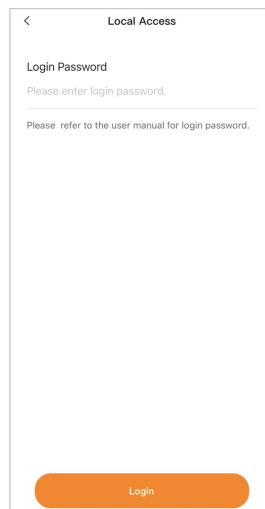

Step 5 Select a charging mode based on your needs, and tap **Continue**. Then, set the server address, and tap **Continue**.

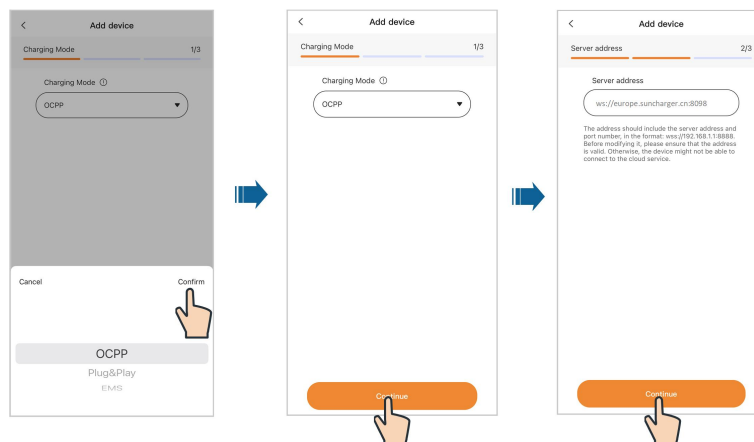

Mode	Description	Note
OCPP	Charge using the stand-alone EV charger.	The default mode for AC007E-01 L1. By default, AC007E-01 L1 does not support EMS charging. Contact customer service for assistance if you require EMS charging.
Plug&Play	Plug and charge.	-
EMS	Available when used with the SUN-GROW solar-energy storage-EV charging system.	The default mode for AC007E-01.



If the charging mode is set to “EMS”, you need to enter the password, which is **the 4-digit PIN code** on the RFID card.



Default server address: `wss://europe.suncharger.cn:20038`.

If you want to add a non-SUNGROW charger, enter the server address provided by the operator.

Step 6 Connect the charger to a stable WLAN network, where you are required to enter the correct password.

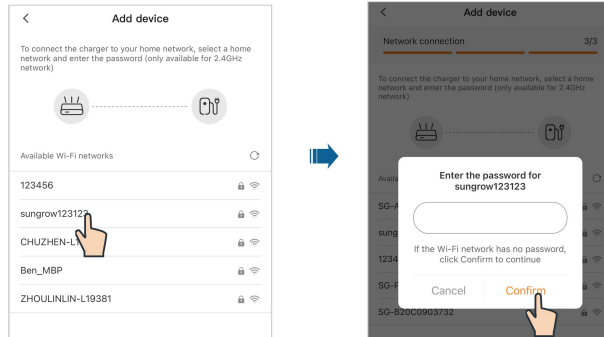

Step 7 After network connection is established successfully, tap **Add device**. The device is now added to your account successfully. Then, tap **Complete**, and you will be directed to the App's Home screen. You can check the status of the charger you have added on this screen.



Disconnect from the charger first, and connect to the router's WLAN network.

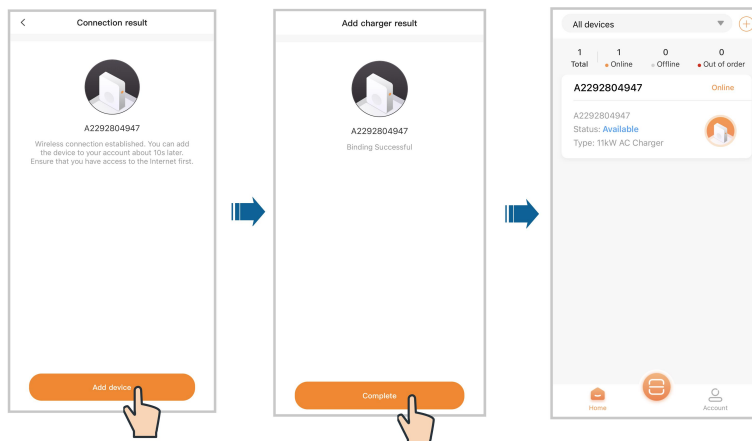

-- End

6.4 Charging View

After a charger has been added, you can start a charging session or modify charging settings remotely on the charging screen of the App.

On the **Home** screen, choose an available charger that has been added before and tap it. You will then go to the charging screen.

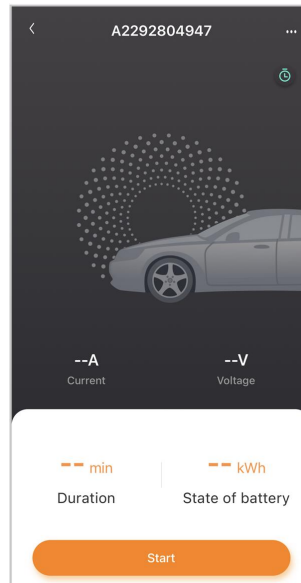

6.4.1 Start/Stop Charging

Start Charging

Tap **Start** on the charging screen to start a charging session. During the charging process, you can view the real-time charging current and voltage, charging time, and battery status.

Stop Charging

If needed, you can tap **Stop** on the charging screen to stop charging immediately.

6.4.2 Scheduled Charging

Step 1 Tap  in the upper right corner of the charging screen to go to "Scheduled charging".

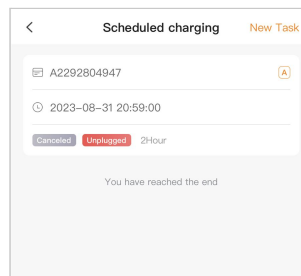

Step 2 Tap **New task** in the upper right corner of this screen. Here you can create a new scheduled charging task.

-- End

6.4.3 Device Settings

Tap  in the upper right corner of the charging screen to go to "Device settings".

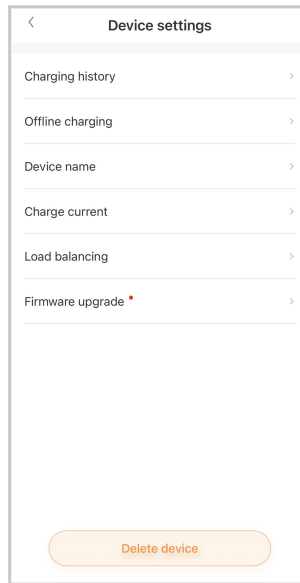

Delete device

Tap **Delete device** at the bottom of the screen to delete the current charger.

Charging history

Tap **Charging history** to view the records of charging history.

Offline charging

Requirements:

- Your phone and the charger have connection to the Internet.
- The charger is available.
- At least one RFID charge card is available.

Tap **Offline charging**. To enable offline charging, tap the toggle button in the upper left corner, and select the charge card you want to use.

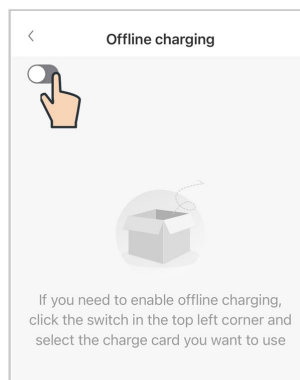



If you have not added an RFID charge card, or you need to add a new card, tap "Add card" at the top right and follow the onscreen instructions to complete the process.



If you switch off offline charging, the respective RFID charge cards must be associated with the charger once again for recognition.

Device name

Tap **Device name**. Enter a name, and tap **Save** to set the device name.

Charge current

Tap **Charge current**. Set the charging current, and tap **Save** to effect the setting.



The regulated charging current applies only to the current charging session.

Load balancing

Requirements:

- The charger is online.
- The charger is not in use.
- The charger has connected to a power-controlling device.

Tap **Load balancing**. Set the "Monitoring method" to **Smart Meter**, and set the "Meter Type" and "Max. Home Load Current" based on the actual situation. Then, tap **Set** to effect the settings.

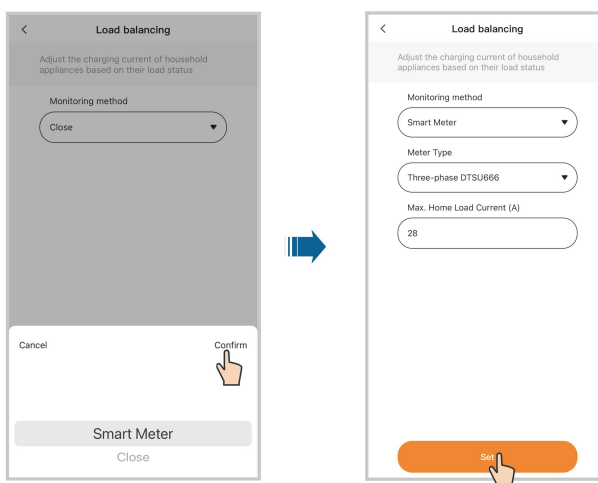

Load balancing is available only for SUNGROW energy meters. Contact the customer service for more details.

Firmware upgrade

Requirements:

- Your phone and the charger have connection to the Internet.
- The charger is available.
- There is a new version of the firmware.

Tap **Firmware upgrade**. Tap **Update** to start remote firmware upgrade.



To ensure proper functionality of the charger, it is recommended to keep the firmware up to date.

6.5 Account

Tap **Account** in the bottom navigation bar. You will then see the screen shown below.

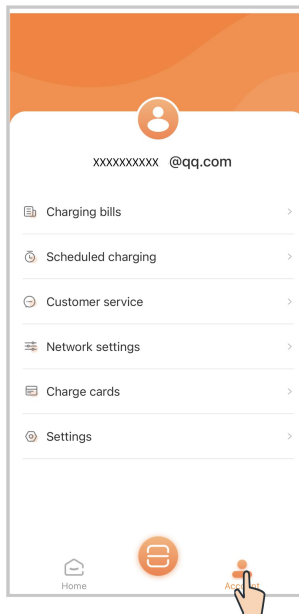

6.5.1 Charging Bills

Step 1 Tap **Charging bills**.

Step 2 Tap **Filter** at the top of the screen, and you can view charging bills by date, device, and charge card number.

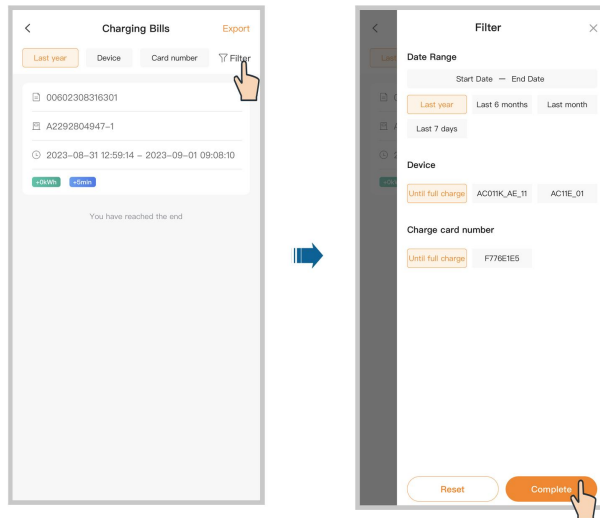

Step 3 Tap **Export** in the upper right corner of the screen to export the charging bills you need.

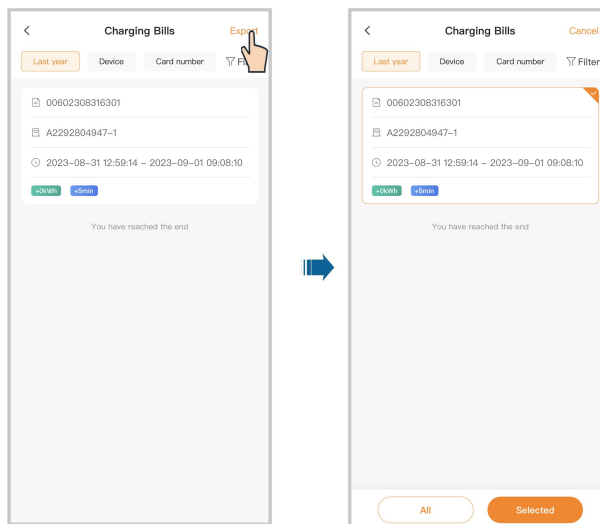

-- End

6.5.2 Scheduled Charging

Step 1 Tap **Scheduled charging**.

Step 2 Tap **New task** in the upper right corner to create a scheduled charging task. Select the device and tap **Add**.

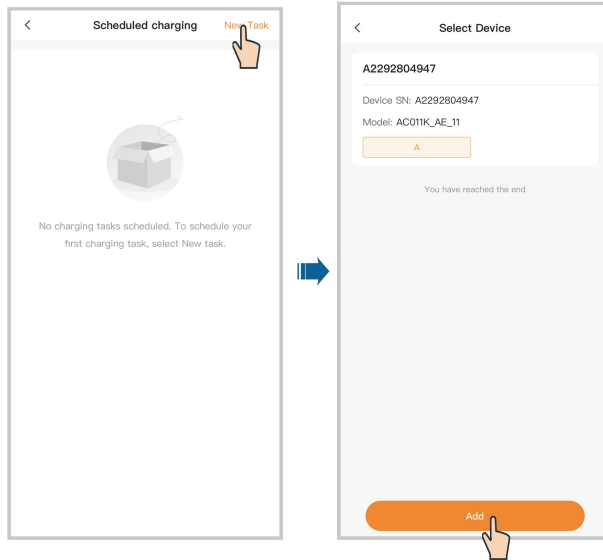

Step 3 Set the start date, start time, and duration, and tap **Start**. A scheduled charging task is now created.

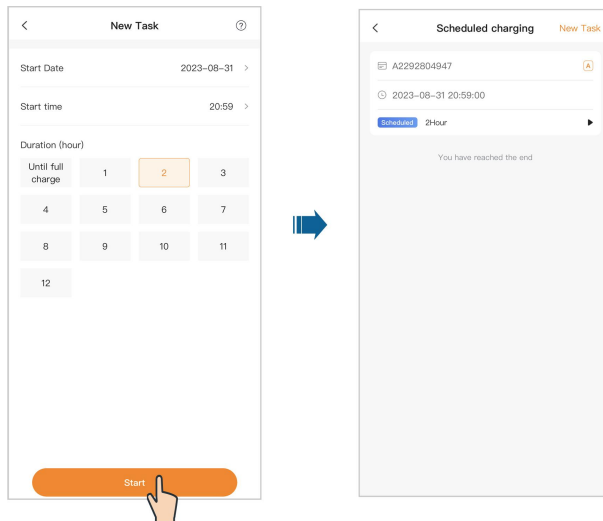

-- End

6.5.3 Customer Service

Tap **Customer service**. You can find the contact information for SUNGROW in some regions on this screen.

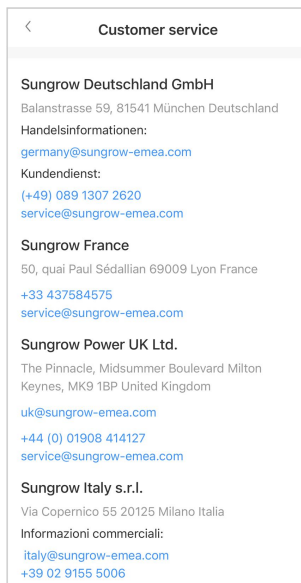

6.5.4 Network Settings

If the WLAN network has changed, please re-configure the network connection for the charger by following the below steps.



To avoid potential interference, it is recommended to enable airplane mode on your mobile device when connecting to the charger's WLAN.

Step 1 Tap **Network settings**, scan the QR code on the side of the charger, and connect the device.

Step 2 Go to WLAN settings on your mobile device, and connect to the charger's WLAN. The charger's WLAN is named as its S/N, and the password is "**admin123**" or **no password** required.

Step 3 Once connected successfully, go back to the App and enter the login password, which should be "**SGC666**", or "**the 4-digit PIN code**" on the back of the charge card. Then, tap **Login**.

Step 4 Choose another stable wireless network. Enter the password and connect the charger to the network.

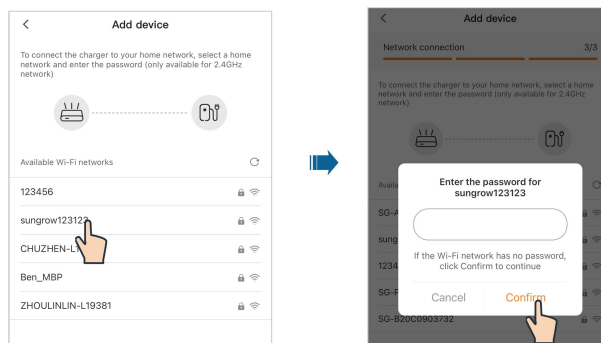

-- End

6.5.5 Firmware Management



“Firmware Management” is accessible to the Administrator account, please contact your distributor or SUNGROW for the Administrator account and password.

Step 1 Tap Firmware Management.

Step 2 Select the device and the module to be upgraded.

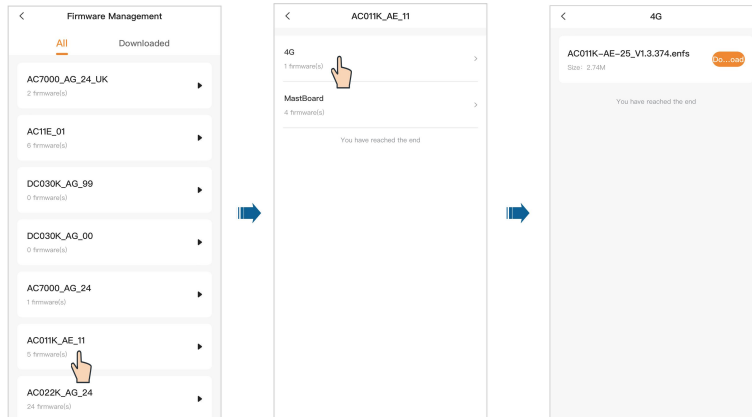

Step 3 Choose the target firmware package and tap Download to download it.

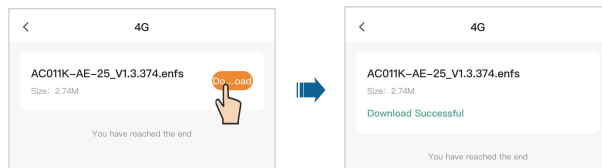

Step 4 Go back to “Firmware Management”. Tap Download, and you can see the firmware package you have downloaded. You can also select the downloaded firmware package and delete it.

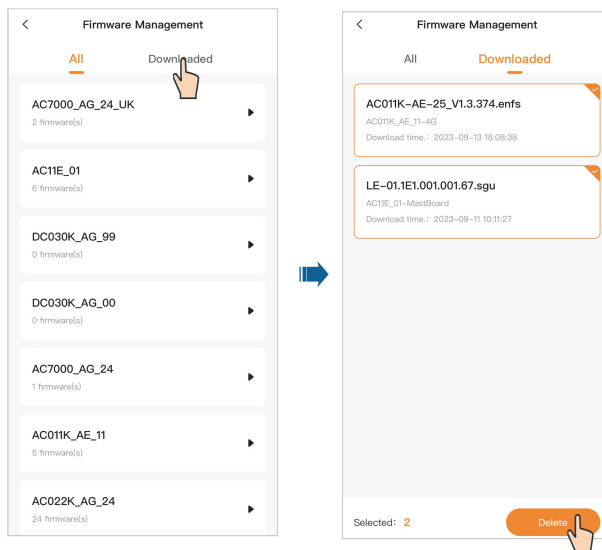

-- End

6.5.6 Device Connection

The "Device Connection" function is used to enable the near-end O&M of the charger.



"Device Connection" is accessible to the Administrator account, please contact your distributor or SUNGROW for the Administrator account and password.

Step 1 Tap **Device Connection**, scan the QR code on the side of the charger and connect the device.

Step 2 Go to WLAN settings on your mobile device, and connect to the charger's WLAN. The charger's WLAN is named as its S/N, and the password is "**admin123**" or **no password** required.

Step 3 Go back to the App, and you will automatically go to the interface for near-end O&M.

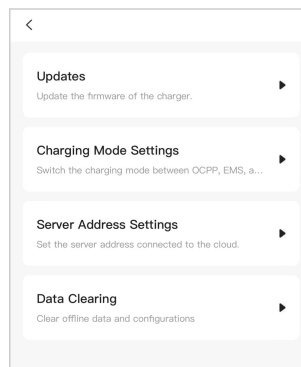

- 1 Tap **Updates**. Here you can select the firmware package that has been downloaded, and tap **Start to Upload** to start firmware upgrade. For details on firmware package download, see "[6.5.5 Firmware Management](#)".
- 2 Tap **Charging Mode Settings**. You can change the charging mode for the current charger on this screen as needed.



If the charging mode is set to "EMS", you need to enter the password, which is **the 4-digit PIN code** on the RFID card.

- 3 Tap **Server Address Settings**. You can change the server address for this charger on this screen as needed.
- 4 Tap **Data Clearing**. You can clear the cache data in the charger.

-- End

6.5.7 Charge Cards

Step 1 Tap **Charge cards**.

Step 2 Tap **Add card** at the bottom of the screen. Then, enter the card name and ID, and tap **Save**. The card is now added successfully.

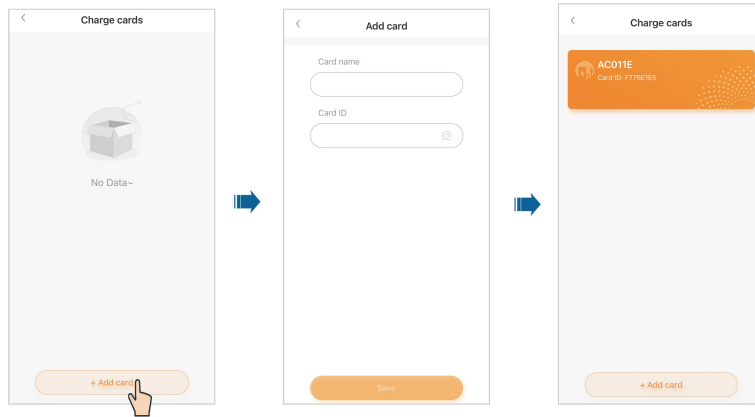

Step 3 Tap the card that has been added, and go to “Card details”. Here you can edit the card name or delete the card.

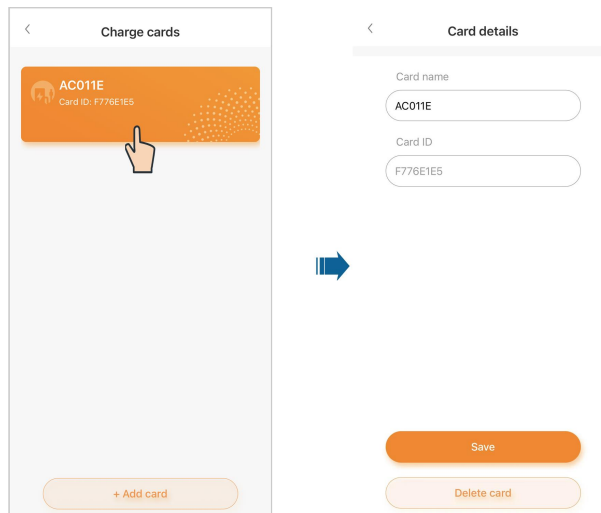

-- End

6.5.8 Settings

Tap **Settings**. Here you can complete settings related to the language of the App, push notifications, email, and password. You can tap **Log out** to log out of the current account.

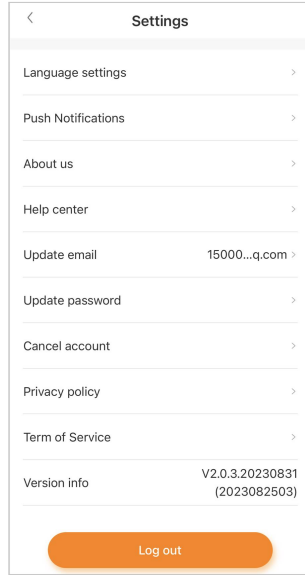

7 Appendix

7.1 Technical Data

Specification	AC007E-01
AC Input and Output	
Max. charge power	7.4 kW
Nominal voltage	230 V
Nominal grid frequency	50 Hz / 60 Hz
Max. current	32 A single-phase
Charge connector	Plug Type 2
Min.cable cross-section	3 * 6 mm ²
Output cable length	7 m
Protection	
Residual current device	6 mA DC
Over/Under voltage protection	Yes
Over load protection	Yes
Over temperature protection	Yes
Surge protection	II
Overvoltage category	III (grid)/II (car)
General Data	
Dimensions (W*H*D)	310 mm * 205 mm * 92 mm
Weight	4.2 kg
Mounting method	Wall-Mounting/Pole-Mounting (optional)
Impact resistance	IK08
Degree of protection	IP65
Operating ambient temperature range	-30 to 50 °C
Allowable relative humidity range (non-condensing)	5 % to 95 %
Cooling method	Natural convection
Max. operating altitude	2000 m

Specification	AC007E-01
Grid type	TN/TT
Display	LED indicator
Monitoring	iSolarCloud App (with Sungrow inverter)
Communication	RS485
Power consumption for standby	< 5 W
Start Mode	RFID card / APP
Compliance	EN/IEC 61851-1:2019; EN/IEC 61851-21-2:2018
Warranty	5 years (standard)

Specification	AC007E-01 L1
AC Input and Output	
Max. charge power	7.4 kW
Nominal voltage	230 V
Nominal grid frequency	50 Hz / 60 Hz
Max. current	32 A single-phase
Charge connector	Plug Type 2
Min.cable cross-section	3 * 6 mm ²
Output cable length	7 m
Protection	
Residual current device	6 mA DC
Over load protection	Yes
Over temperature protection	Yes
Surge protection category	II
General Data	
Dimensions (W*H*D)	310 mm * 205 mm * 92 mm
Weight	4.2 kg
Mounting method	Wall-Mounting/Pole-Mounting (optional)
Impact resistance	IK08
Degree of protection	IP65
Operating ambient temperature range	-30 to 50 °C
Allowable relative humidity range (non-condensing)	5 % to 95 %

Specification	AC007E-01 L1
Cooling method	Natural convection
Max. operating altitude	2000 m
Grid type	TN/TT
Display	LED indicator
Monitoring	iEnergyCharge App
Communication	WIFI
Power consumption for standby	< 5 W
Start Mode	RFID card / APP
Compliance	EN/IEC 61851-1:2019; EN/IEC 61851-21-2:2018
Warranty	3 years (standard)

7.2 Quality Assurance

In the event of a defect during the warranty period, SUNGROW will provide free of charge service or replace the product with a new one.

Evidence

During the warranty period, the customer shall provide the product purchase invoice and date. In addition, the trademark on the product shall be undamaged and legible. Otherwise, SUNGROW has the right to refuse to honor the quality guarantee.

Conditions

- After replacement, unqualified products shall be processed by SUNGROW.
- The customer shall give SUNGROW a reasonable period to repair the faulty device.

Exclusion of Liability

In the following circumstances, SUNGROW has the right to refuse to honor the quality guarantee:

- The free warranty period for the whole machine/components has expired.
- The device is damaged during transport.
- The device is incorrectly installed, refitted, or used.
- The device operates in harsh conditions beyond those described in this manual.
- The fault or damage is caused by installation, repairs, modification, or disassembly performed by a service provider or personnel, not from SUNGROW.
- The fault or damage is caused by the use of non-standard or non-SUNGROW components or software.
- The installation and use range are beyond the stipulations of relevant international standards.

- The damage is caused by unexpected natural factors.

For faulty products in any of the above cases, if the customer requests maintenance, paid maintenance service may be provided based on the judgment of SUNGROW.

7.3 Contact Information

In case of questions about this product, please contact us.

We need the following information to provide you with the best assistance:

- Model of the device
- Serial number of the device
- Fault code/name
- Brief description of the problem

For detailed contact information, please visit <https://en.sungrowpower.com/contactUS>.

SUNGROW

Sungrow Power Supply Co., Ltd.
www.sungrowpower.com