

# FusionSolar App

# User Manual

**Issue** 01  
**Date** 2024-02-07



**Copyright © Huawei Digital Power Technologies Co., Ltd. 2024. All rights reserved.**

No part of this document may be reproduced or transmitted in any form or by any means without prior written consent of Huawei Digital Power Technologies Co., Ltd.

## **Trademarks and Permissions**



HUAWEI and other Huawei trademarks are the property of Huawei Technologies Co., Ltd.

All other trademarks and trade names mentioned in this document are the property of their respective holders.

## **Notice**

The purchased products, services and features are stipulated by the contract made between Huawei Digital Power Technologies Co., Ltd. and the customer. All or part of the products, services and features described in this document may not be within the purchase scope or the usage scope. Unless otherwise specified in the contract, all statements, information, and recommendations in this document are provided "AS IS" without warranties, guarantees or representations of any kind, either express or implied. The information in this document is subject to change without notice. Every effort has been made in the preparation of this document to ensure accuracy of the contents, but all statements, information, and recommendations in this document do not constitute a warranty of any kind, express or implied.

## **Huawei Digital Power Technologies Co., Ltd.**

Address: Huawei Digital Power Antuoshan Headquarters

Futian, Shenzhen 518043

People's Republic of China

Website: <https://digitalpower.huawei.com>

---

# Contents

---

<b>1</b>	<b>Downloading and Installing the App.....</b>	<b>1</b>
<b>2</b>	<b>Registering the Company's First Installer Account.....</b>	<b>3</b>
<b>3</b>	<b>Registering an Owner Account or Another Installer Account.....</b>	<b>5</b>
<b>4</b>	<b>Logging In to or Logging Out of FusionSolar App.....</b>	<b>7</b>
<b>5</b>	<b>Creating a User.....</b>	<b>9</b>
<b>6</b>	<b>I'm an Installer.....</b>	<b>12</b>
6.1	Setup Wizard.....	12
6.1.1	Device Commissioning (EMMA).....	12
6.1.1.1	Setting Router Parameters of the Charger.....	12
6.1.1.2	Quick Settings.....	13
6.1.2	Device Commissioning (Charger).....	21
6.1.2.1	Charging-only.....	21
6.1.2.1.1	Charger FE Port Directly Connected to a Meter.....	23
6.1.2.1.2	Charger FE Port Directly Connected to a Router.....	25
6.1.2.1.3	Charger Connected to a Router Through WLAN.....	28
6.1.2.2	PV+ESS+Charger/ Charging-only (EMMA Scenario).....	31
6.1.2.3	PV+ESS+Charger (Smart Dongle/Inverter WLAN Direct Connection Scenario).....	32
6.1.3	Device Commissioning (PV+ESS).....	32
6.1.4	Connecting to a Plant.....	33
6.1.4.1	Connecting to a New Plant.....	33
6.1.4.2	Connecting to an Existing Plant.....	35
6.1.4.3	Connecting Devices to a Plant with Multiple Installers.....	35
6.1.5	Adding a Device.....	38
6.1.6	Setting the String Capacity.....	39
6.1.7	Setting Electricity Prices (Simple Price).....	39
6.1.8	Set Electricity Prices (Compound Price).....	39
6.1.8.1	Purpose.....	40
6.1.8.2	Setting the Feed-in Tariff.....	40
6.1.8.3	Configuring a Purchase Price.....	40
6.1.8.4	Example of Configuring an Electricity Price.....	41
6.1.8.4.1	Example of Configuring an Electricity Price (Scenario 1).....	41

6.1.8.4.2 Example of Configuring an Electricity Price (Scenario 2).....	43
6.1.8.5 More Operations.....	44
6.1.8.5.1 Applying the Purchase Prices to Other Plants.....	44
6.1.8.5.2 Setting Holidays.....	44
6.1.8.5.3 Adding a Purchase Price Template.....	44
6.1.9 Creating a Physical Location Layout.....	45
6.1.9.1 Automatically Generating a Physical Layout.....	45
6.1.9.2 Manually Creating a Physical Layout.....	47
6.1.9.3 Binding Optimizers and Inverters.....	51
6.1.9.4 Viewing a Physical Layout.....	53
6.2 Plant Overview.....	54
6.2.1 Viewing Status of a Charging-only Plant.....	55
6.2.2 Viewing Status of a PV+ESS+Charger Plant.....	59
6.2.3 Viewing EMMA Revenue and Energy Forecast.....	62
6.2.4 Optimizer Disconnection Detection.....	62
6.3 O&M Management.....	63
6.3.1 Monitoring Alarm Information.....	63
6.3.2 Mobile O&M.....	65
6.3.2.1 Defect Elimination.....	65
6.3.2.2 Inspection Management.....	67
6.4 Device Management.....	71
6.5 Permission Management.....	72
6.6 Log Export.....	73
6.7 Services.....	75
<b>7 I'm an Owner.....</b>	<b>77</b>
7.1 Viewing the PV Plant Status.....	79
7.2 Viewing the Battery Running Status.....	81
7.3 Using a Charger.....	81
7.3.1 Starting and Stopping Charging on the App.....	82
7.3.2 Start Charging Through Authentication via Bluetooth.....	82
7.3.3 Starting and Stopping Charging Using an RFID Card.....	83
7.3.4 Plug-and-Play Charging.....	84
7.3.5 Scheduled Charging.....	84
7.3.6 Charging for the Next Trip.....	86
7.3.7 Sharing the Charger.....	87
7.3.8 Viewing Charging Records.....	88
7.3.9 Load Priority.....	89
7.3.10 Settings.....	90
7.4 Using a Shared Charger.....	93
7.4.1 Registering a Shared Account.....	93
7.4.2 Starting and Stopping Charging on the App.....	93
7.4.3 Setting the Charging Connector Locking Mode.....	94

7.4.4 Logout.....	95
7.5 Smart Appliance.....	95
7.5.1 Quick Guide to Smart Appliances.....	95
7.5.2 Adding a Smart Appliance (Owner).....	95
7.5.3 Quick Guide to PV Power Preferred.....	97
7.5.4 Enabling PV Power Preferred Mode.....	101
7.5.5 Power Consumption Schedule.....	102
7.5.6 Setting PV Power Parameters.....	103
7.5.7 Setting the Load Priority.....	104
7.5.8 More Settings.....	105
7.5.8.1 Parameter Settings.....	105
7.5.8.2 Setting Communication Parameters for Smart Appliances.....	106
7.6 Load Shedding.....	107
7.7 Managing Devices.....	108
7.8 Managing Plants.....	112
7.9 Enabling EMMA.....	115
7.10 Setting Electricity Prices (Simple Price).....	117
7.11 Set Electricity Prices (Compound Price).....	117
7.11.1 Purpose.....	117
7.11.2 Setting the Feed-in Tariff.....	117
7.11.3 Configuring a Purchase Price.....	118
7.11.4 Example of Configuring an Electricity Price.....	118
7.11.4.1 Example of Configuring an Electricity Price (Scenario 1).....	118
7.11.4.2 Example of Configuring an Electricity Price (Scenario 2).....	120
7.11.5 More Operations.....	121
7.11.5.1 Applying the Purchase Prices to Other Plants.....	122
7.11.5.2 Setting Holidays.....	122
7.11.5.3 Adding a Purchase Price Template.....	122
7.12 Processing a Plant Migration Task.....	122
7.13 Processing an Upgrade Task.....	122
7.14 Log Export.....	123
7.15 Permission Management.....	124
7.16 Services.....	126
<b>8 Device Commissioning.....</b>	<b>128</b>
<b>9 Account Security Settings.....</b>	<b>129</b>
9.1 Verifying an Email Address.....	129
9.2 Changing Personal Passwords.....	130
9.3 Modifying Personal Information.....	131
<b>10 FAQs.....</b>	<b>133</b>
10.1 Resetting a Password Using the Associated Email Address.....	133
10.2 Resetting a User Password.....	134

10.3 Troubleshooting the No Data Fault After a User Logs In to App.....	135
10.4 Handling a Network Exception When a User Logs In to App.....	136
10.5 How Do I Reset the Default Password of a Charger Using an RFID Card When I Forgot the Password?.....	136
10.6 How Do I Connect to a Charger When I Cannot Log In to the FusionSolar App Due to Poor Network Connection?.....	137
10.7 What Should I Do If the Charging Connector Cannot Be Removed From the Charger?.....	138
10.8 What Should I Do If the App Cannot Identity the Charger?.....	139
10.9 Upgrading the Charger Software Version.....	139
10.10 What Should I Do If the Upgrade Package Obtained from an iPhone Cannot Be Selected on the Upgrade Screen?.....	140
10.11 What Should I Do If an Offline or Faulty Charger Is Displayed in the Plant After the Charger Is Replaced?.....	142
10.12 Why Is the Charger Displayed as Offline in the Management System after Factory Settings Are Restored?.....	143
10.13 Why Is the Pairing Request Displayed Twice During Bluetooth Pairing?.....	146
10.14 How Do I Obtain a Registration Code?.....	146
10.15 What Should I Do If My Android Phone Fails to Connect to the WLAN After I Scan the QR Code?.....	147
10.16 Obtaining a Physical Layout Template.....	147
10.17 How Do I Invite a User to Register a FusionSolar Account?.....	148
10.18 How Do I Register a FusionSolar Account?.....	149
10.19 How Do I Add or Delete an RFID Card?.....	149
10.20 What Can I Do If the System Prompts Me to Reconnect to the Charger's WLAN Hotspot During Quick Settings?.....	152
10.21 Why Is the Display of Some Screens Incomplete or Abnormal After I Enlarge the Font Size on My Phone?.....	152
10.22 How Can I Change the WLAN Password of a Device?.....	152
10.23 How Do I Navigate to the Device Local Commissioning Screen?.....	153
10.24 What Should I Do If the Device Is Disconnected from the App When I Switch the Local Commissioning Screen to the Background?.....	155
10.25 How Can I Delete the Offline Legacy Devices in the FusionSolar SmartPVMS After I Use a New SmartGuard?.....	156
10.26 What Can I Do If the Password Is Incorrect When I Connect to the Charger WLAN?.....	156
<b>11 Related Information.....</b>	<b>157</b>
11.1 PV Power Generation Offsetting Carbon Emissions.....	158
11.2 Environment Parameters.....	161
11.3 Power Parameters.....	162
11.4 Battery Parameters.....	167
11.5 Domain Name List of Management Systems.....	173
11.6 Public URLs.....	175

# 1 Downloading and Installing the App

## NOTICE

- Mobile phone operating system: Android 8.0, iOS 11.0, or later versions.
- To ensure the stability of each function, you are advised to use mobile phones running Android 8.0, iOS 13.0, or later versions. (For the mobile phones running iOS, iPhone 6 and later versions are supported, but iPhone SE is not supported.)
- Use mobile phones that support the access to the Internet.
- Use mobile phones that support the WLAN function.
- The router supports 2.4 GHz WLAN, and the WLAN signal reaches the device.
- The WPA, WPA2, or WPA/WPA2 encryption mode is recommended for routers. The Enterprise mode is not supported (such as airport WLAN and other public hotspots that require authentication). WEP and WPA TKIP are not recommended because they have serious security vulnerabilities. If the access fails in WEP mode, log in to the router and change the encryption mode of the router to WPA2 or WPA/WPA2.

## Procedure

Method 1: Download and install the app from the app store.

- Huawei mobile phone users: Search for **FusionSolar** in Huawei AppGallery.
- iPhone users: Search for **FusionSolar** in the App Store.
- Other mobile phone users: Select method 2.



Method 2: Scan the QR code to download and install the app.



 NOTE

Users who select method 2 can select the download method based on the mobile phone type.

- Huawei mobile phone users: Download from Huawei AppGallery.
- Non-Huawei phone users: Download on a browser.

When you select **Download via the Browser**, if a security warning message is displayed indicating that the app is from an external source, tap **ALLOW**.

# 2 Registering the Company's First Installer Account

---

An installer account is required for device deployment and commissioning. If you do not have an installer account of the FusionSolar SmartPVMS or FusionSolar app, perform the following steps to register an account.

## Intended Audience

Installers who have not registered a company with the FusionSolar SmartPVMS or FusionSolar app.

Owners who commission chargers by themselves.

### NOTE

If your company has registered an account, contact the administrator to add you to the company.

## Procedure

1. Tap **No account?** in the lower part of the FusionSolar app login screen.
2. On the **Role** screen, tap **I'm an installer** and register an account as prompted.

After the account is registered, you can log in to the FusionSolar app with the registered username and password.

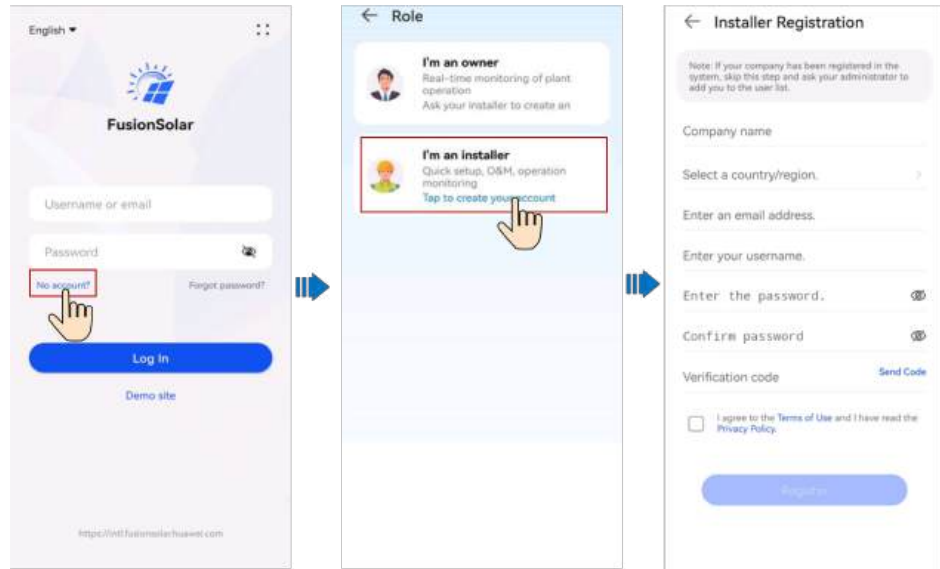

# 3 Registering an Owner Account or Another Installer Account

---

- If self-service registration is not supported in your region, your installer needs to **create an account** for you and bind a plant. After the account is created, the system will send you the username and initial password by email.
- If self-service registration is supported in your region, your installer needs to initiate an **invitation**. After receiving an invitation email from the installer, you can **register an account** on the registration screen according to the instructions.

After the account is registered, you can log in to the FusionSolar app with the registered username and password.

1. Invite a user.

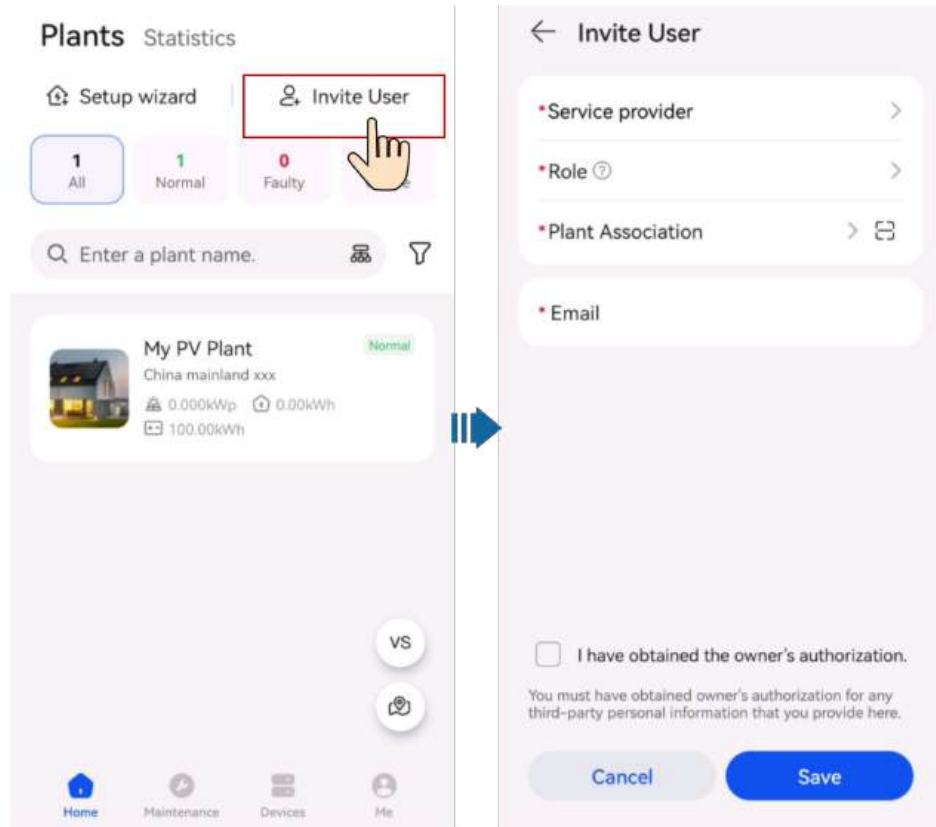

2. Register an account.

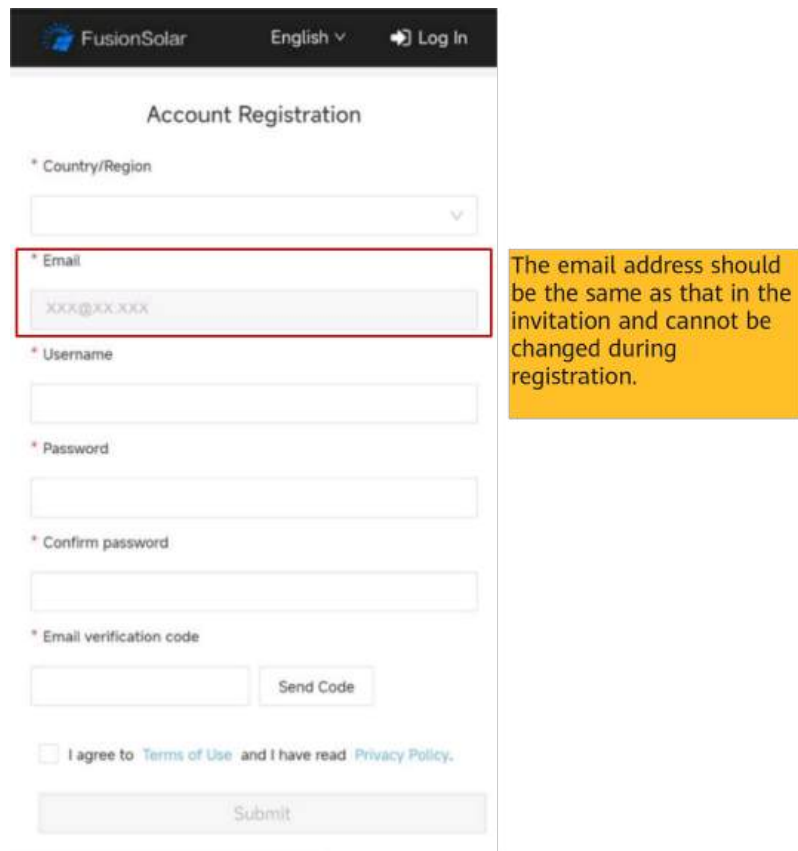

# 4 Logging In to or Logging Out of FusionSolar App

After the app is correctly installed on a mobile phone, you can access the management system through the app.

## Logging In to the App

1. On the mobile device, tap the app icon to access the login screen.
2. On the app login screen, enter the account and password and tap **Log In**.

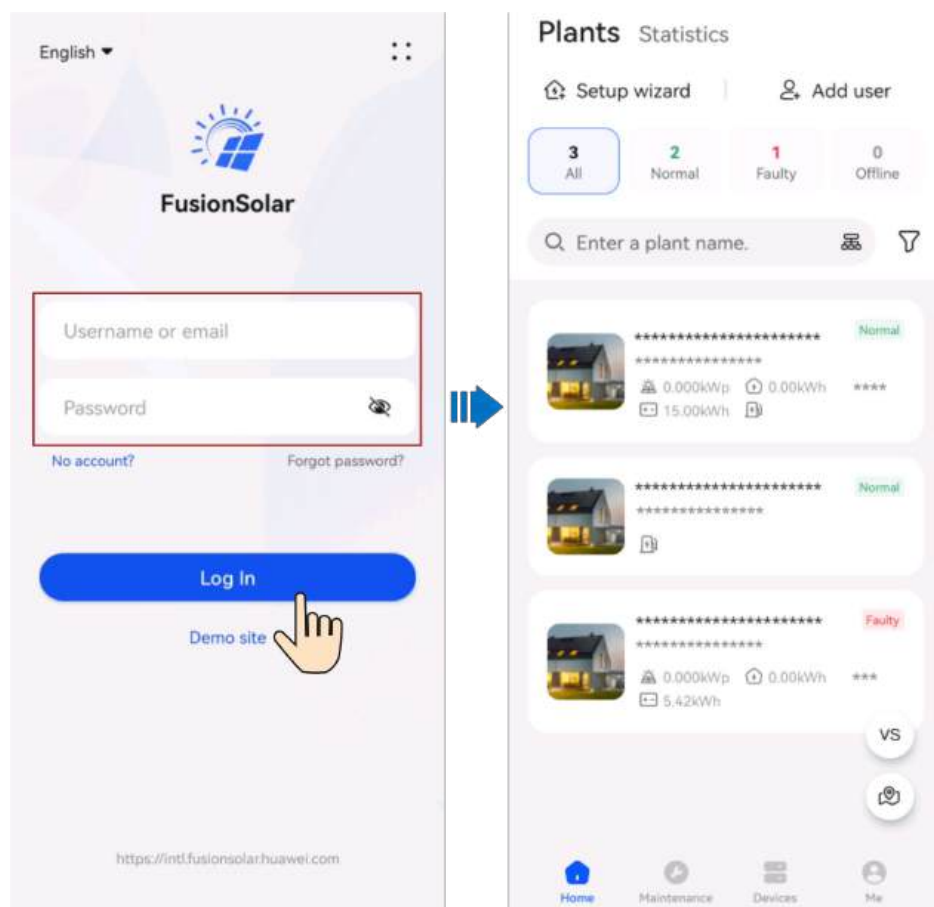

 **NOTE**

- If a new user logs in to the app for the first time or a user logs in to the app for the first time after the password is reset, change the login password as prompted.
- If a user enters incorrect passwords for five consecutive times within 5 minutes, the account will be locked for 30 minutes. The user can log in again after the lockout period expires or contact the installer or administrator to unlock the account.

## Logging Out of the App

1. On the home screen, tap **Me**.
2. On the **Me** screen, tap **Settings** > **Log out**.

# 5 Creating a User

---

An installer can create owner user accounts and installer user accounts on the FusionSolar app. Owner users can monitor the device running status and start charging. Installer users can perform wizard-based commissioning and plant creation, monitor the running status of the plants, manage devices, query alarms, and perform mobile O&M.

When creating a user, ensure that the plant to be associated is available. If your company has created a plant, you can directly create a user and associate the user to the plant. If your company has not created a plant, create a plant and then add a user. For details, see [6.1.4 Connecting to a Plant](#).

## Creating an Owner User

On the **Home** screen, tap **Plants**. Tap **Add user** and create an account as prompted.

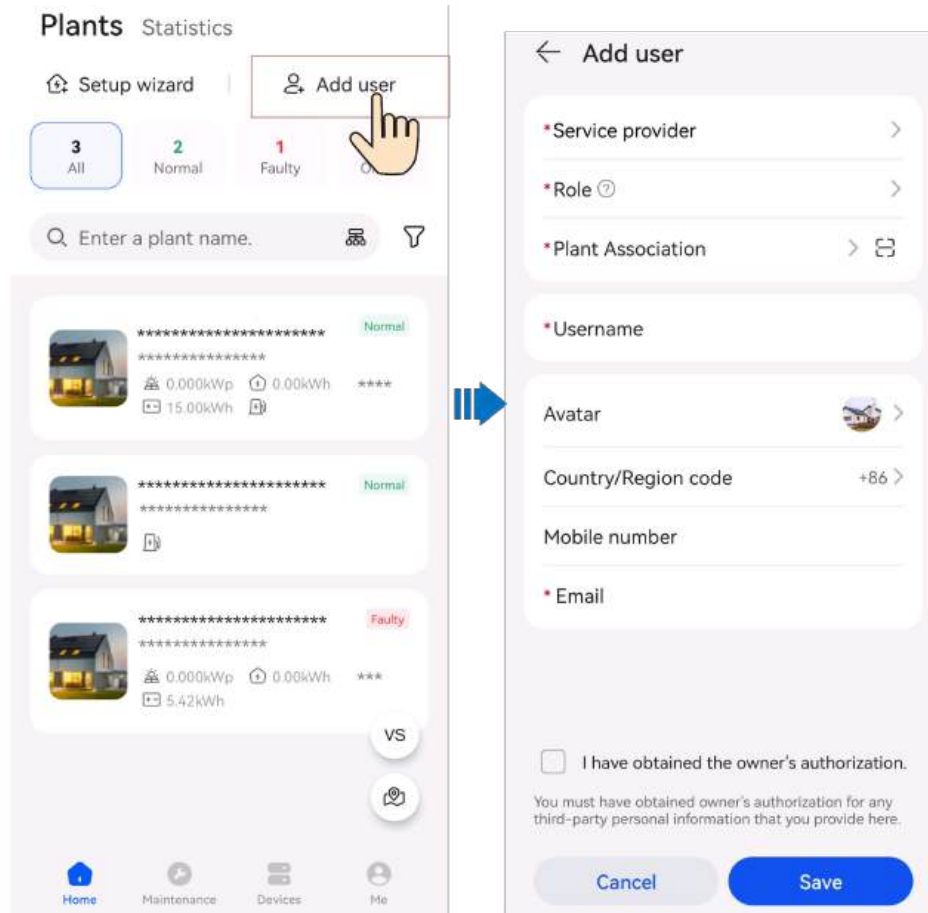

**NOTE**

After an account is created, the system sends a notification to the entered email address. Then the user can use the received username and password to log in to the FusionSolar SmartPVMS or FusionSolar app.

## Creating an Installer User

1. On the **Home** screen, tap **Plants**. Tap **Add user** and create an account as prompted.

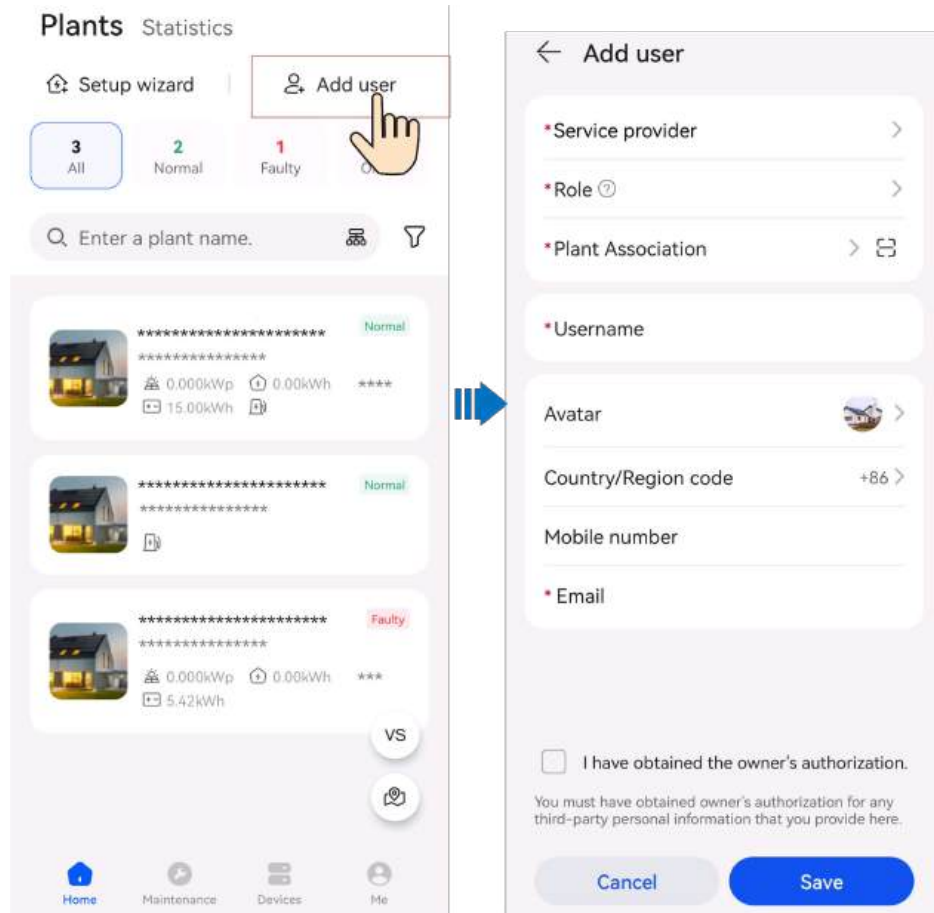

**NOTE**

- For a new user who is assigned the **Installer** role, if the user is associated with only plants, the installer can manage the associated plants within the permission of the role but cannot create a plant. If the installer is associated with a company, the installer can manage all plants of the associated company and has the permission to create plants.
- After an account is created, the system sends a notification to the entered email address. Then the user can use the received username and password to log in to the FusionSolar SmartPVMS or FusionSolar app.

# 6 I'm an Installer

---

An installer can perform wizard-based commissioning and plant creation on the FusionSolar app, and monitor the overall running status of the plants. If a device is faulty, the installer can perform maintenance on the app to rectify the fault.

## 6.1 Setup Wizard

After devices are installed and commissioned, you can create a plant and configure basic information on the FusionSolar app to implement unified device monitoring and O&M.

### 6.1.1 Device Commissioning (EMMA)

#### 6.1.1.1 Setting Router Parameters of the Charger

When the charger is connected to the router over WLAN, you need to set the route parameters of the charger so that the charger and EMMA are connected to the same router. Otherwise, the EMMA cannot identify the charger in the network.

 **NOTE**

Skip this section if no charger is available or the charger is directly connected to the router through the FE port.

1. Connect to the local commissioning screen of the charger. For details, see [Connect to the charger](#).
2. Tap **O&M > Route Management** and select **WLAN**.

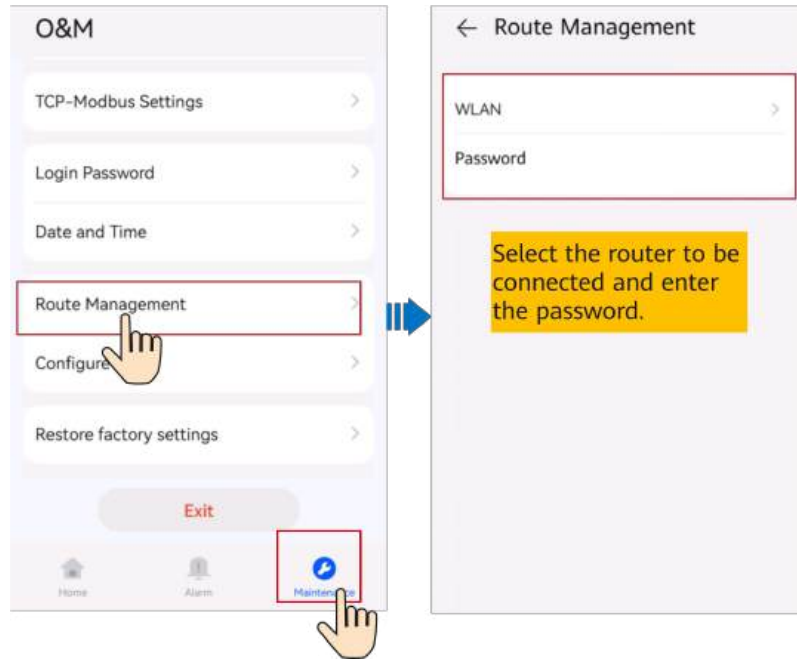

### 6.1.1.2 Quick Settings

The charger must be upgraded to the FusionCharge V100R023C10 to match the EMMA networking. Otherwise, the EMMA cannot find the charger. [Connect to the charger](#) as an installer. For details about the upgrade operations, see [Upgrading the Charger Software Version](#).

1. Log in to the FusionSolar app as an installer, tap **Setup wizard** on the **Home** screen, scan the QR code of the device, and follow the instructions to connect to the WLAN.

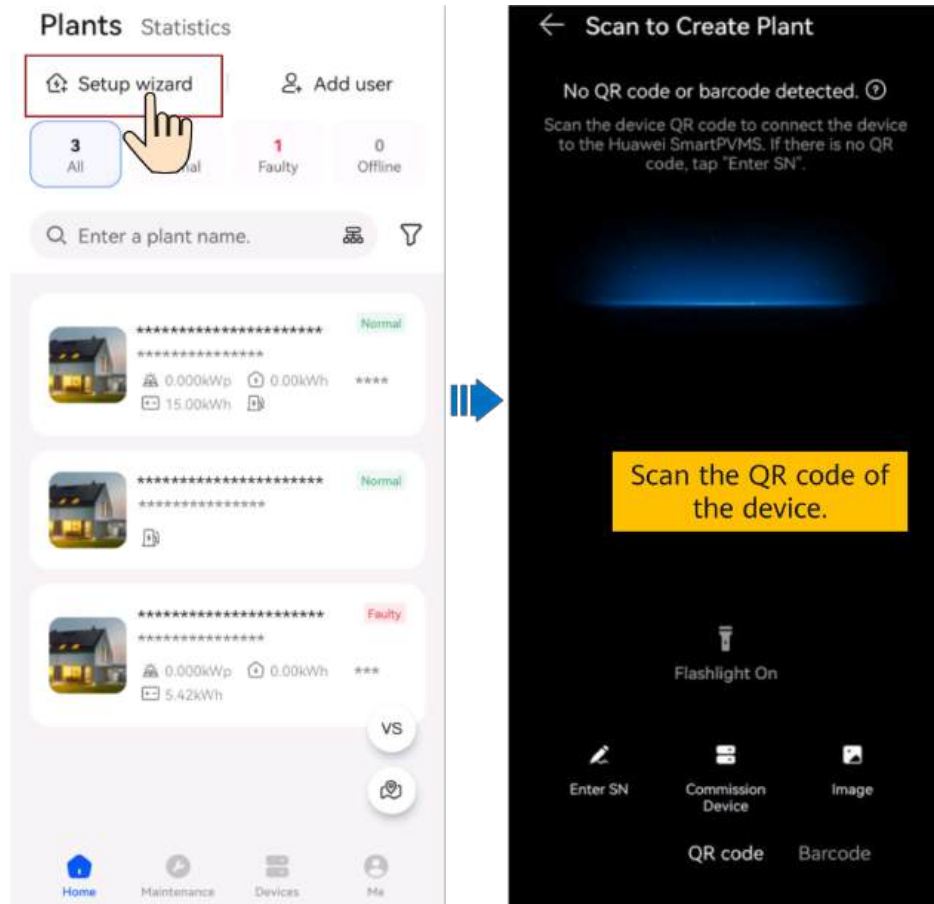

**NOTE**

- The last six digits of the product WLAN name are the same as the last six digits of the product SN.
  - Use the initial password to log in for the first time and change the password as prompted.
  - To ensure account security, protect the password by changing it periodically, and keep it secure. Your password might be stolen or cracked if it is left unchanged for extended periods. If a password is lost, devices cannot be accessed. In these cases, the Company shall not be liable for any loss.
  - If the login screen is not displayed after you scan the QR code, check whether the device is correctly connected to the WLAN network. If not, manually select and connect to the WLAN network.
  - If the **This WLAN network has no Internet access. Connect anyway?** message is displayed when you connect to the device WLAN, tap **CONNECT**. Otherwise, you cannot log in to the system. The actual UI and messages may vary with mobile phones.
2. Log in to the app as **Installer** and commission the device according to the wizard.

**NOTE**

- Change the initial password as prompted at the first login. Ensure account security by changing the password periodically.
- Setting router parameters
  - Connect the EMMA to the home router to ensure that the charger in the network can be detected.

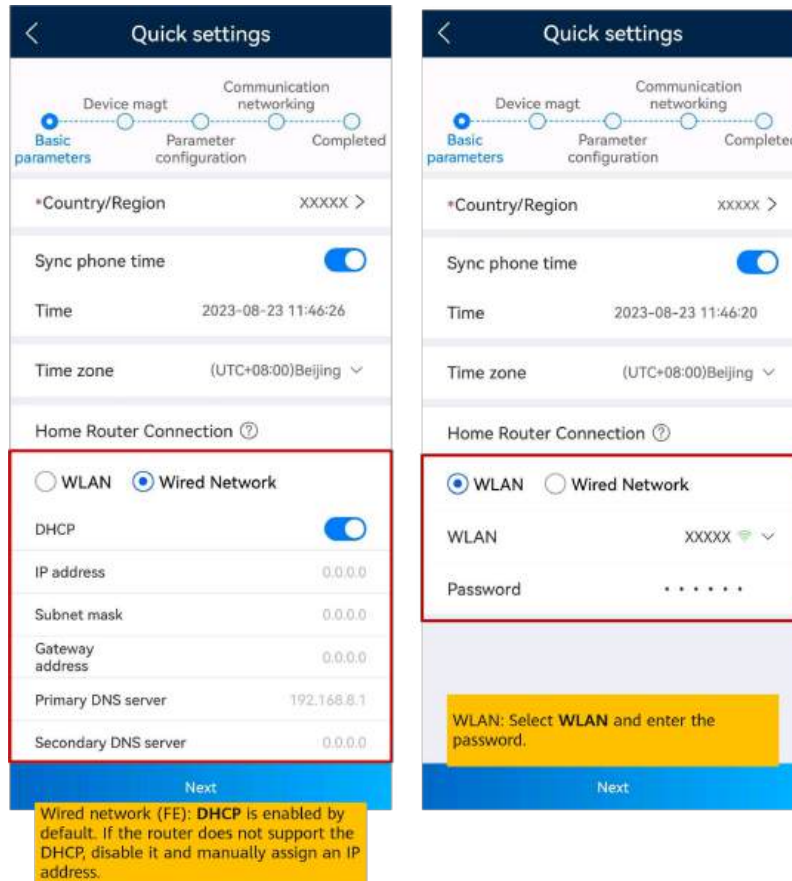

**NOTE**

- Ensure that the router supports 2.4 GHz WLAN and the WLAN signal reaches the device.
- If a charger is used, ensure that the charger and EMMA are connected to the same router. Otherwise, the charger cannot be connected.

– **Device Management**

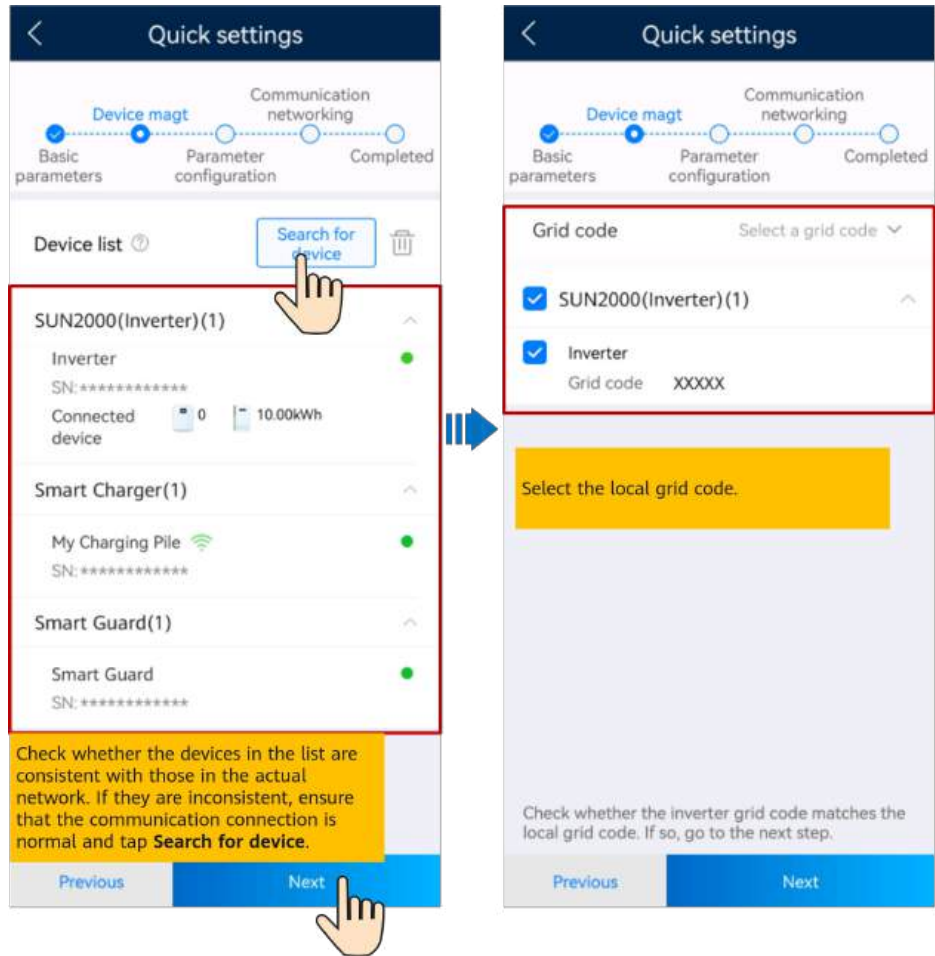

– **Parameter configuration**

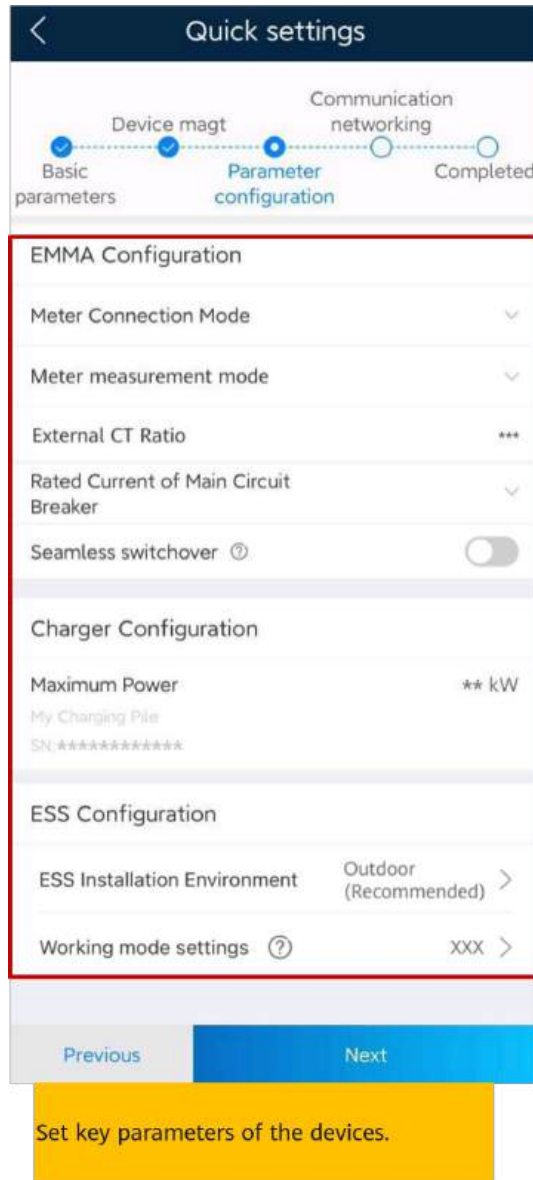

**Table 6-1** Parameter description

Device	Parameter	Description
EMMA	<b>Main Circuit Breaker Capacity</b>	<p>Used for home appliance overload protection. Set the rated current of the main circuit breaker based on the site requirements.</p> <p>When the EMMA detects that the actual current exceeds the preset value, it limits the power purchased from the grid and shuts down loads by power consumption priority in ascending order until the actual current is lower than the preset value.</p> <p><b>NOTE</b> The feed-in power is not limited by this parameter.</p>

Device	Parameter	Description
	<b>Meter Connection Mode</b>	Configure this parameter based on the actual cable connection mode of the meter. <b>NOTICE</b> Select a correct cable connection mode for the meter based on the actual scenario. Otherwise, some functions related to the meter may be abnormal.
	<b>Meter measurement mode</b>	Measures the home current. The internal CT can collect a maximum of 63 A current. When the home current is greater than 63 A, an external CT is required.
	<b>External CT Ratio</b>	When <b>Meter measurement mode</b> is selected as <b>External CT</b> connection, the external CT ratio needs to be configured.
	<b>Seamless switchover</b>	<b>Enabled:</b> When the power grid fails, the system switches to the off-grid state within 20 ms to ensure that loads are not powered off. <b>Disabled:</b> Loads will be powered off temporarily during the on/off-grid switchover. <b>NOTE</b> This parameter needs to be configured only in the SmartGuard scenario.
Charger	<b>Maximum Power</b>	Maximum charge power of the charger (less than or equal to the rated power of the charger).
ESS	<b>Working mode</b>	<b>Maximum self-consumption</b> PV energy is preferentially supplied to loads, and then the surplus PV energy is charged to the ESS. If the ESS is fully charged or is being charged at full power, the surplus PV energy is fed to the power grid. When PV energy is insufficient or no PV energy can be generated at night, the ESS discharges energy to loads. This improves the self-consumption rate and energy self-sufficiency rate, and reduces electricity costs. The grid cannot charge the ESS.

Device	Parameter	Description
		<p><b>Fully fed to grid:</b> This mode maximizes the PV energy fed to the grid. When the generated PV energy in the daytime is greater than the maximum output capability of the inverter, the surplus energy is used to charge the ESS. When the generated PV energy is less than the maximum output capability of the inverter, the ESS discharges energy to the inverter to maximize the energy fed from the inverter to the grid. The grid cannot charge the ESS.</p> <p>Note: The grid cannot charge the ESS.</p> <hr/> <p><b>TOU:</b> Charge and discharge time segments are manually set.</p> <p>During the charge period, the grid can charge the ESS. During the discharge period, the ESS can supply power to the loads. In other time segments, the ESS does not discharge power. The PV system and grid supply power to loads, and the PV system can charge the ESS. (In on/off-grid mode, if the grid fails, the ESS can discharge power at any time.)</p> <p>Note: In some countries, the grid is not allowed to charge the ESS. In this case, do not use this mode.</p>

- **Communications Networking**

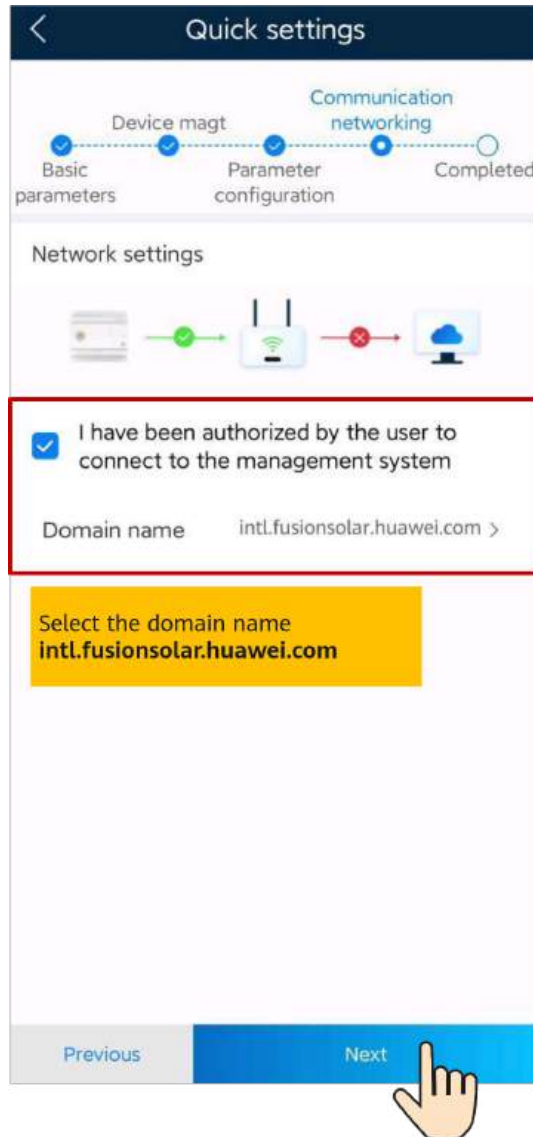

3. Tap **Connection Test** to check the communication status between devices and the WLAN signal strength of devices to identify possible faults. You can identify and rectify faults by viewing rectification suggestions to ensure that the system runs properly.



4. Tap **Finish** and connect devices to a plant as prompted. For details, see [6.1.4 Connecting to a Plant](#).

## 6.1.2 Device Commissioning (Charger)

### 6.1.2.1 Charging-only

#### NOTE

6.23.00.157 and later versions support chargers and new functions. Update the app to the latest version before connecting to chargers.

The chargers can implement dynamic power by connecting to the DTSU666-FE meter or the WLAN/FE Smart Dongle in the PV system through virtual meter networking to obtain RS485 meter detection data. Perform commissioning based on the actual networking scenarios of chargers, meters, and routers.

**Figure 6-1** Charger FE port directly connected to a meter

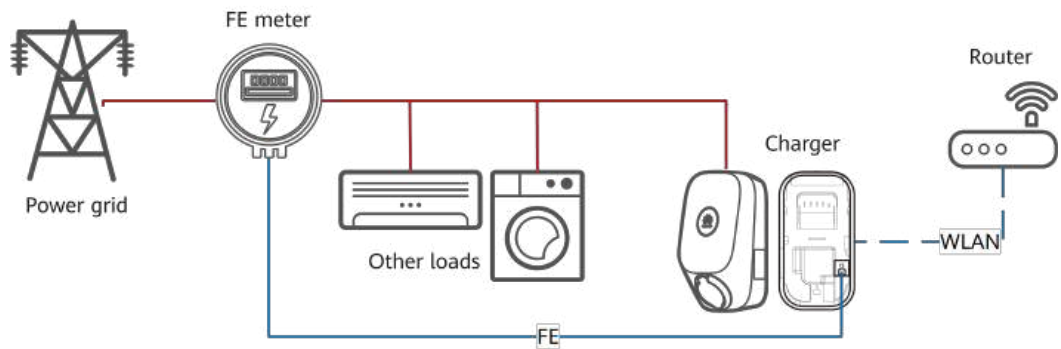

For details about the commissioning procedure, see [6.1.2.1.1 Charger FE Port Directly Connected to a Meter](#).

**Figure 6-2** Charger FE port directly connected to a router

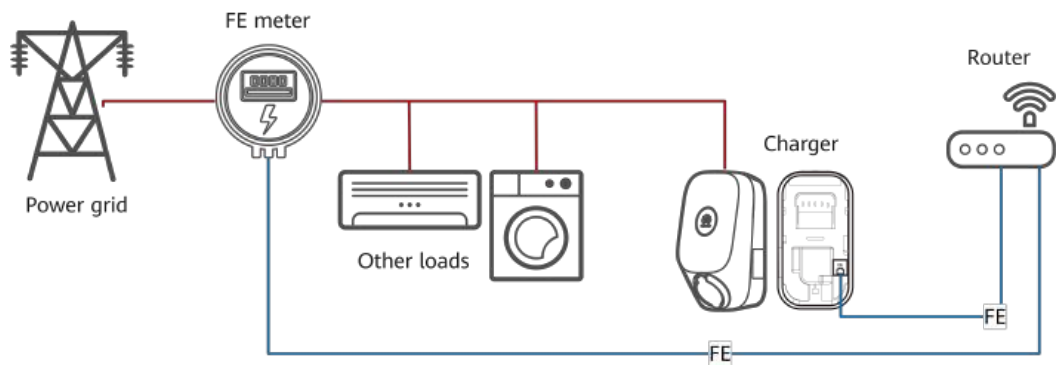

For details about the commissioning procedure, see [6.1.2.1.2 Charger FE Port Directly Connected to a Router](#).

**Figure 6-3** Charger connected to a router through WLAN

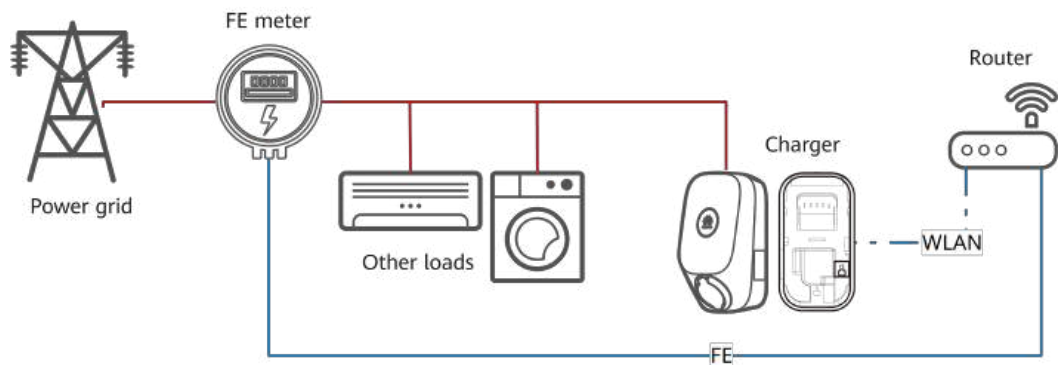

For details about the commissioning procedure, see [6.1.2.1.3 Charger Connected to a Router Through WLAN](#).

### 6.1.2.1.1 Charger FE Port Directly Connected to a Meter

1. Log in to the FusionSolar app as an installer, tap **Setup wizard** on the **Home** screen, scan the QR code of the device, and follow the instructions to connect to the WLAN.

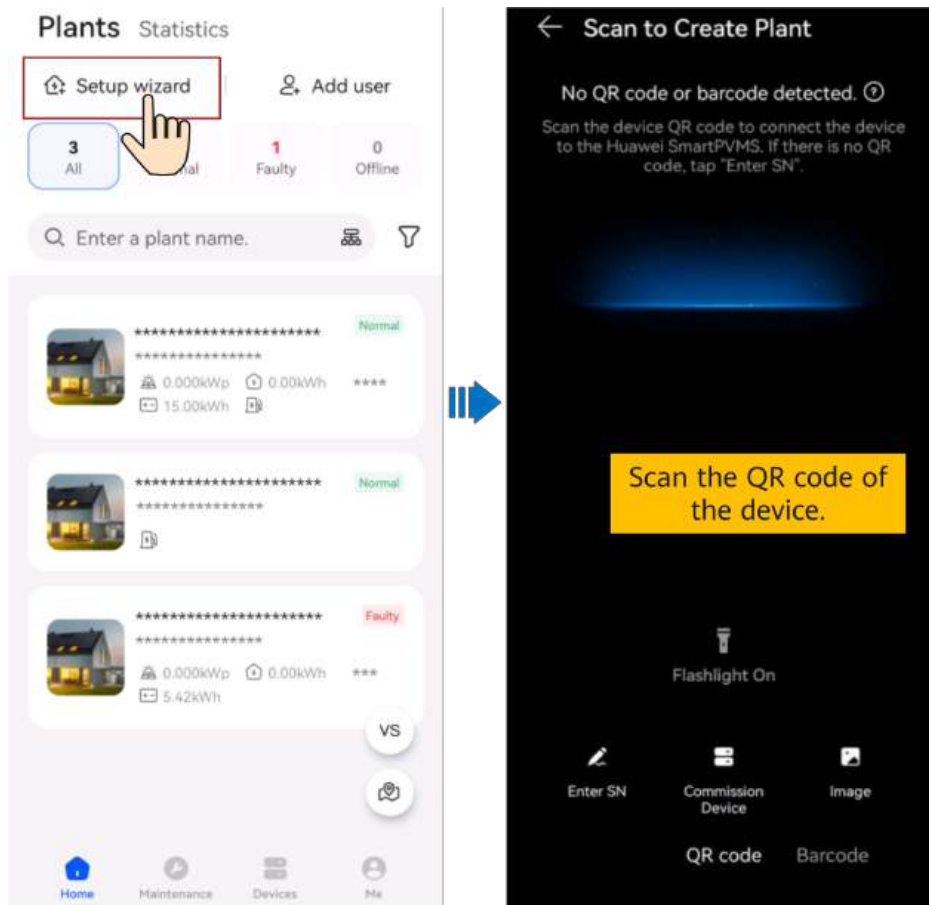

#### NOTE

- The last six digits of the product WLAN name are the same as the last six digits of the product SN.
  - Use the initial password to log in for the first time and change the password as prompted.
  - To ensure account security, protect the password by changing it periodically, and keep it secure. Your password might be stolen or cracked if it is left unchanged for extended periods. If a password is lost, devices cannot be accessed. In these cases, the Company shall not be liable for any loss.
  - If the login screen is not displayed after you scan the QR code, check whether the device is correctly connected to the WLAN network. If not, manually select and connect to the WLAN network.
  - If the **This WLAN network has no Internet access. Connect anyway?** message is displayed when you connect to the device WLAN, tap **CONNECT**. Otherwise, you cannot log in to the system. The actual UI and messages may vary with mobile phones.
2. Log in to the app as an **Installer**.

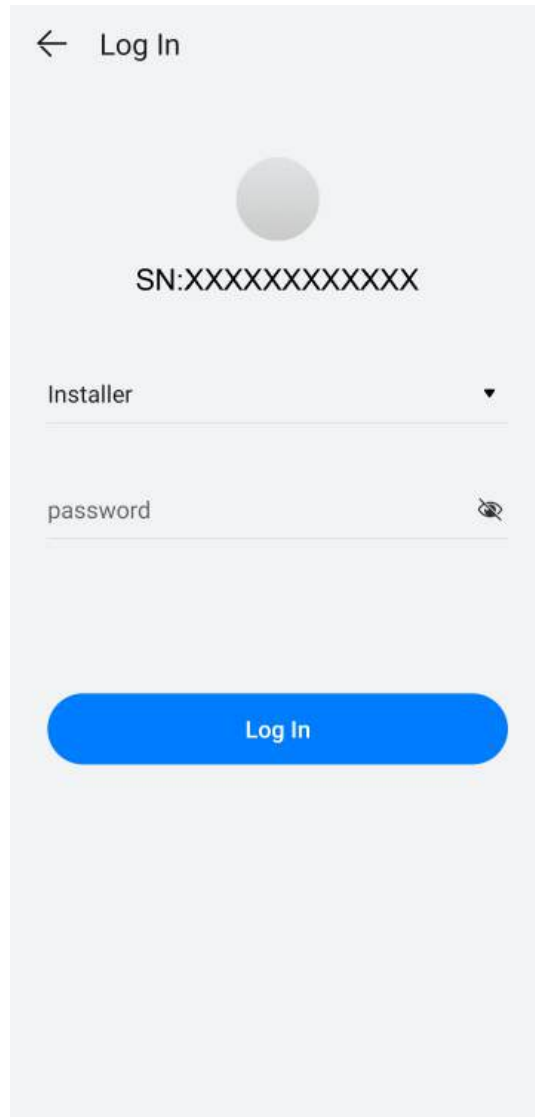

 **NOTE**

For the first login, the initial password is **Changeme**. If the system prompts you to set a password, set the login password as prompted.

3. Commission the device according to the wizard procedure.

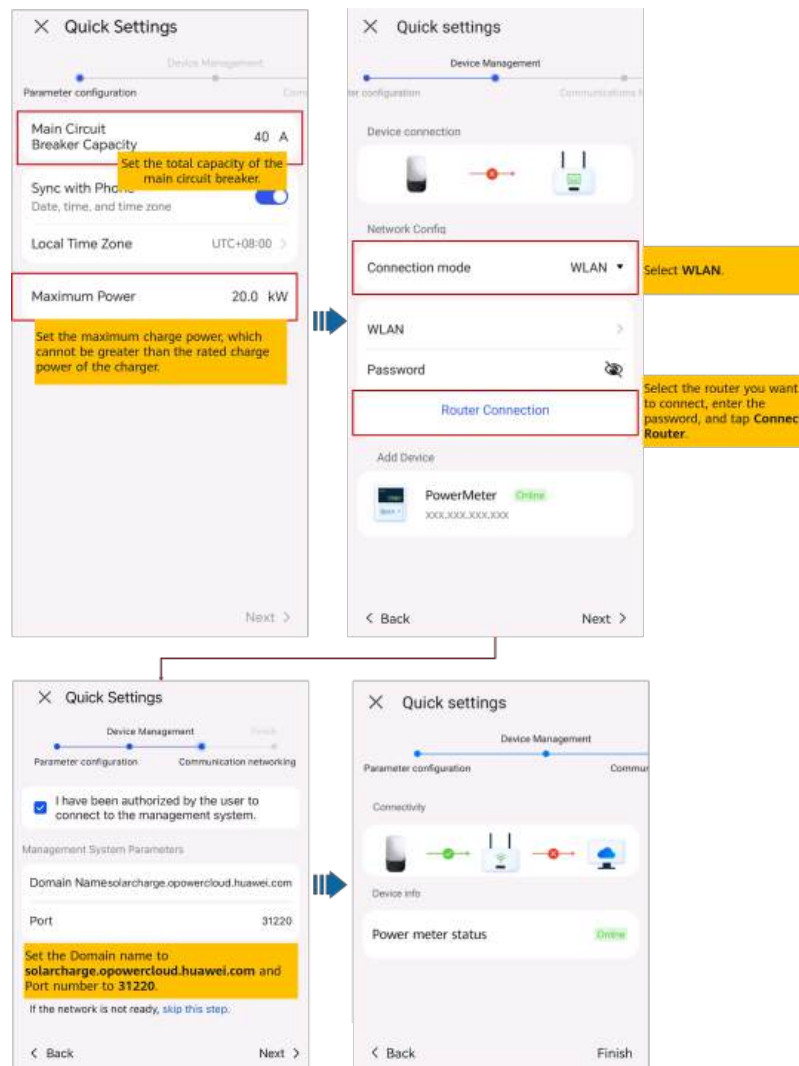

**NOTE**

Set the capacity of the main circuit breaker based on site requirements. If the set value is greater than the actual capacity, the circuit breaker trips due to overcurrent. If the set value is less than the actual capacity, the charger cannot work.

4. Tap **Finish** and connect devices to a plant as prompted. For details, see [6.1.4 Connecting to a Plant](#).

### 6.1.2.1.2 Charger FE Port Directly Connected to a Router

1. Log in to the FusionSolar app as an installer, tap **Setup wizard** on the **Home** screen, scan the QR code of the device, and follow the instructions to connect to the WLAN.

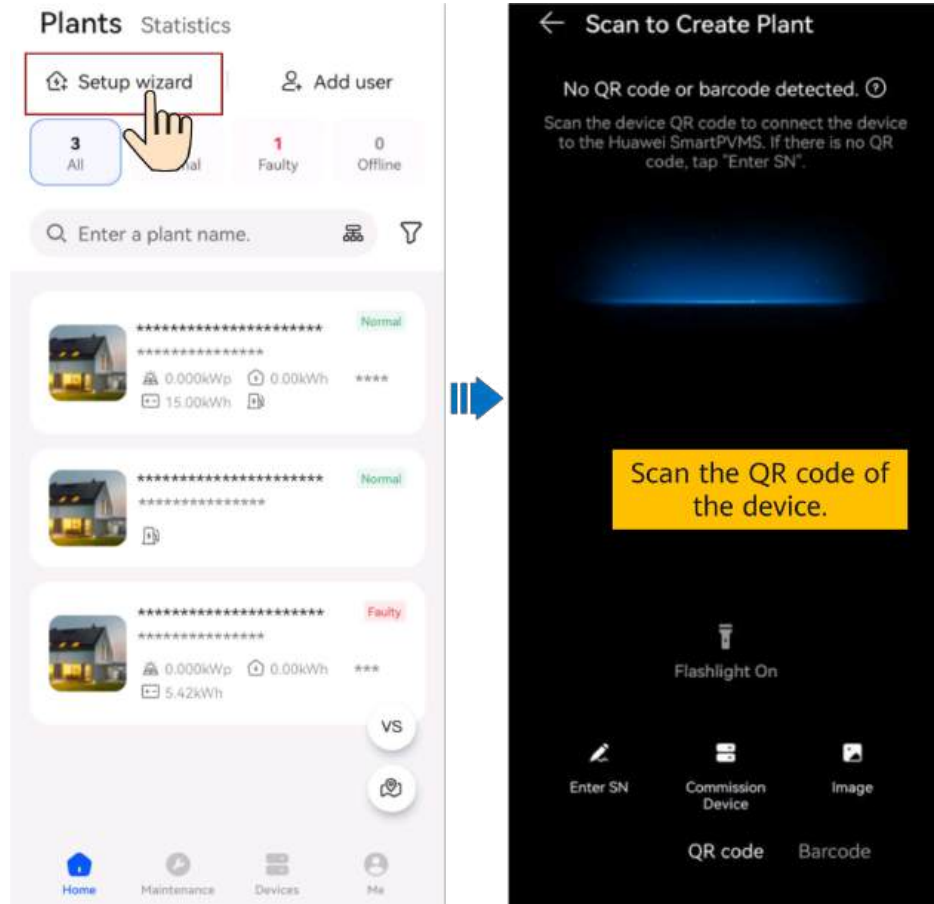

**NOTE**

- The last six digits of the product WLAN name are the same as the last six digits of the product SN.
  - Use the initial password to log in for the first time and change the password as prompted.
  - To ensure account security, protect the password by changing it periodically, and keep it secure. Your password might be stolen or cracked if it is left unchanged for extended periods. If a password is lost, devices cannot be accessed. In these cases, the Company shall not be liable for any loss.
  - If the login screen is not displayed after you scan the QR code, check whether the device is correctly connected to the WLAN network. If not, manually select and connect to the WLAN network.
  - If the **This WLAN network has no Internet access. Connect anyway?** message is displayed when you connect to the device WLAN, tap **CONNECT**. Otherwise, you cannot log in to the system. The actual UI and messages may vary with mobile phones.
2. Log in to the app as an **Installer**.

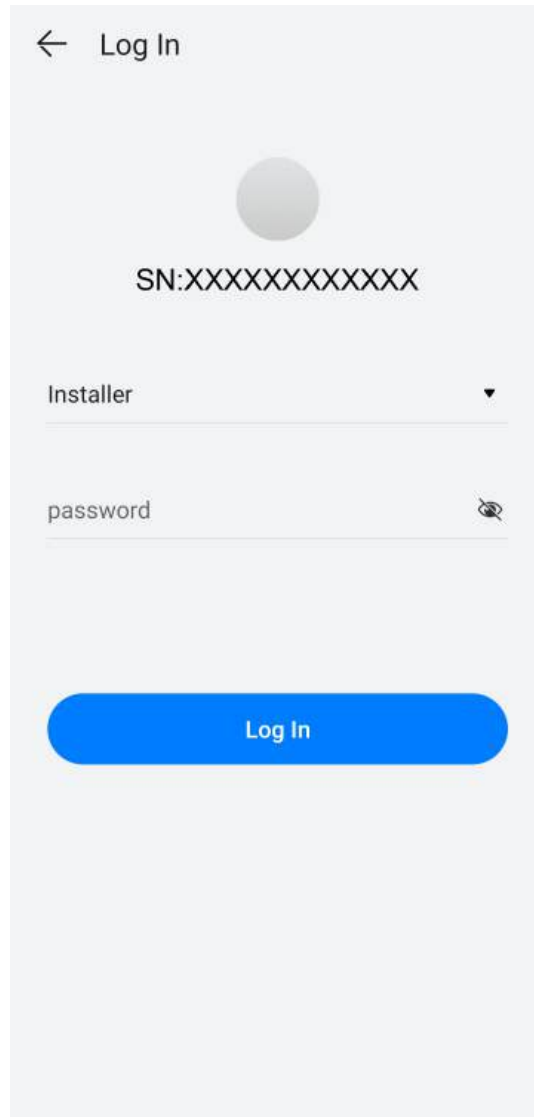

 **NOTE**

For the first login, the initial password is **Changeme**. If the system prompts you to set a password, set the login password as prompted.

3. Commission the device according to the wizard procedure.

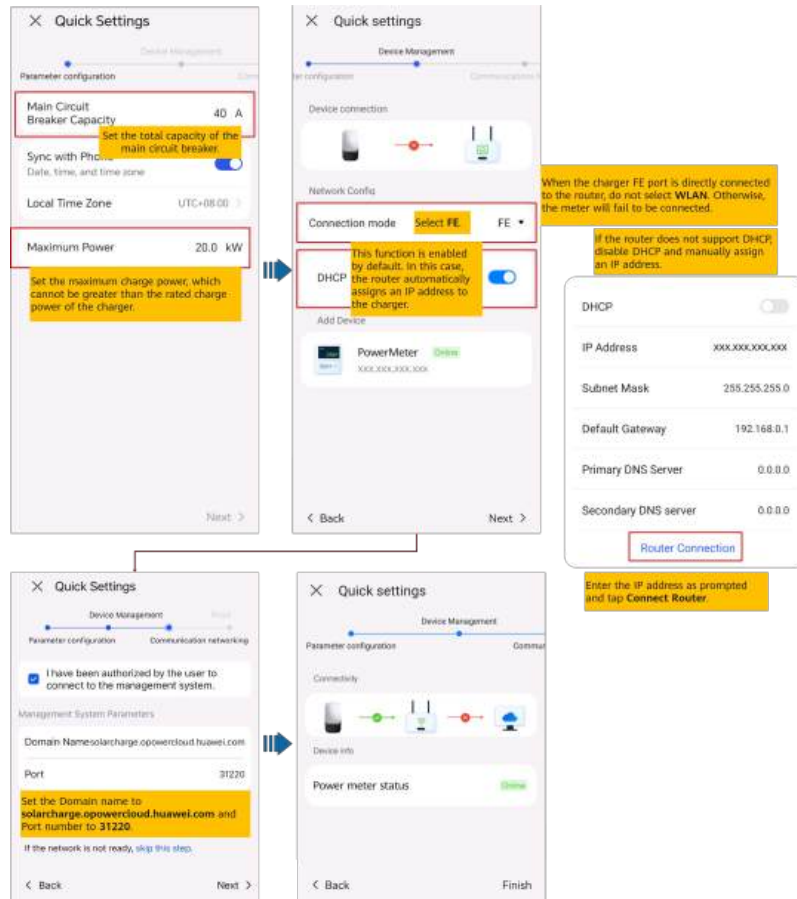

**NOTE**

Set the capacity of the main circuit breaker based on site requirements. If the set value is greater than the actual capacity, the circuit breaker trips due to overcurrent. If the set value is less than the actual capacity, the charger cannot work.

4. Tap **Finish** and connect devices to a plant as prompted. For details, see [6.1.4 Connecting to a Plant](#).

### 6.1.2.1.3 Charger Connected to a Router Through WLAN

1. Log in to the FusionSolar app as an installer, tap **Setup wizard** on the **Home** screen, scan the QR code of the device, and follow the instructions to connect to the WLAN.

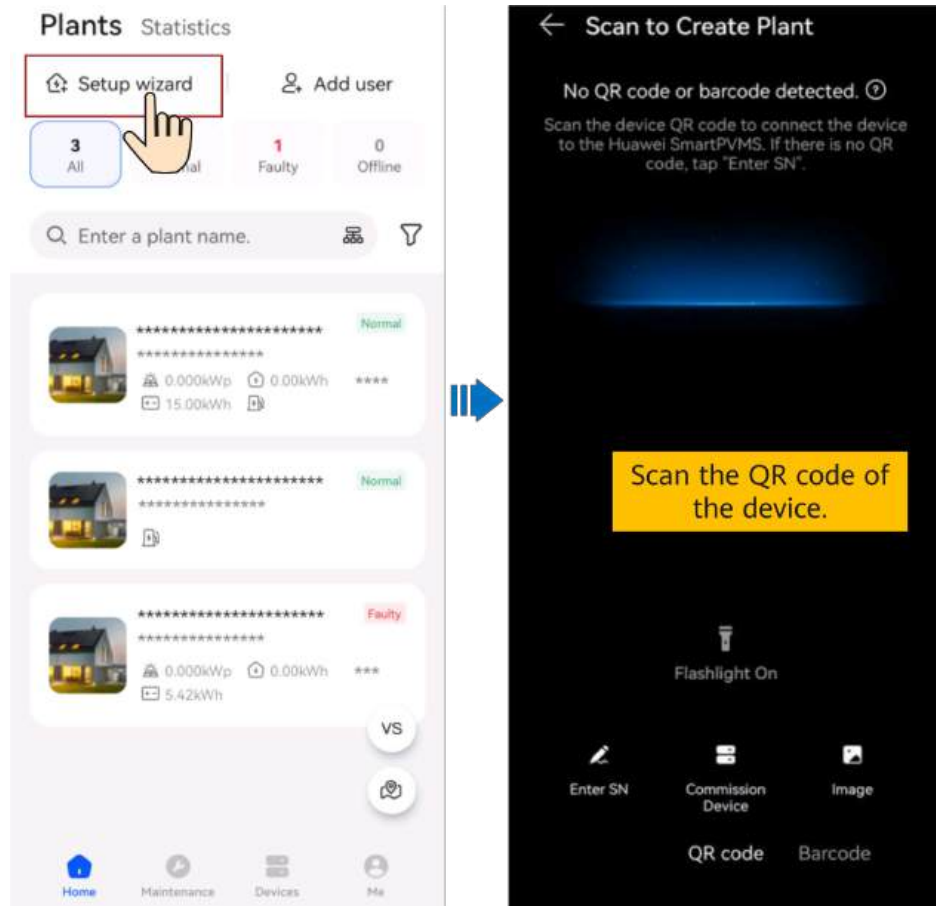

**NOTE**

- The last six digits of the product WLAN name are the same as the last six digits of the product SN.
- Use the initial password to log in for the first time and change the password as prompted.
- To ensure account security, protect the password by changing it periodically, and keep it secure. Your password might be stolen or cracked if it is left unchanged for extended periods. If a password is lost, devices cannot be accessed. In these cases, the Company shall not be liable for any loss.
- If the login screen is not displayed after you scan the QR code, check whether the device is correctly connected to the WLAN network. If not, manually select and connect to the WLAN network.
- If the **This WLAN network has no Internet access. Connect anyway?** message is displayed when you connect to the device WLAN, tap **CONNECT**. Otherwise, you cannot log in to the system. The actual UI and messages may vary with mobile phones.

2. Log in to the app as an **Installer**.

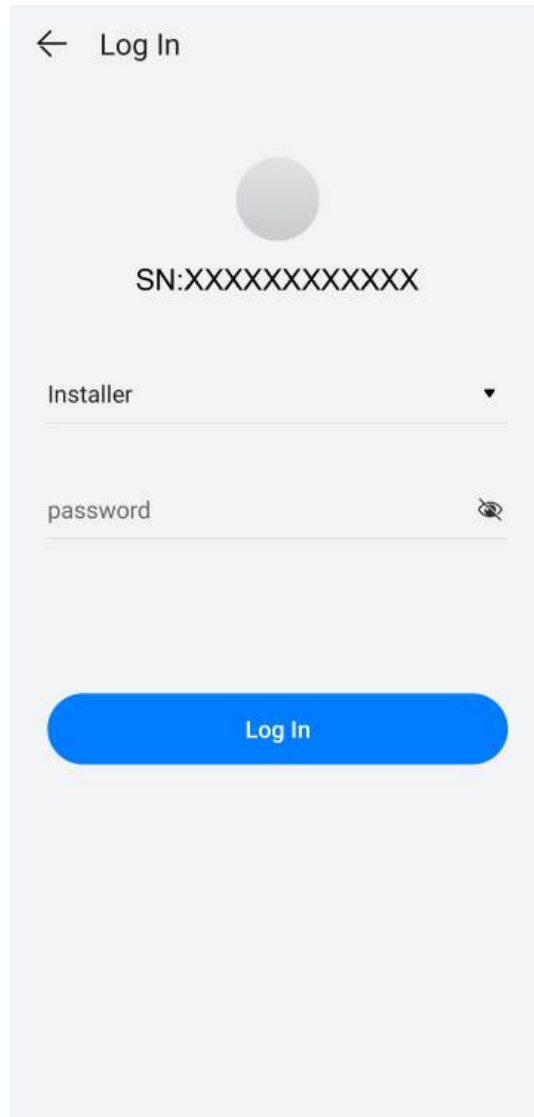

 **NOTE**

For the first login, the initial password is **Changeme**. If the system prompts you to set a password, set the login password as prompted.

3. Commission the device according to the wizard procedure.

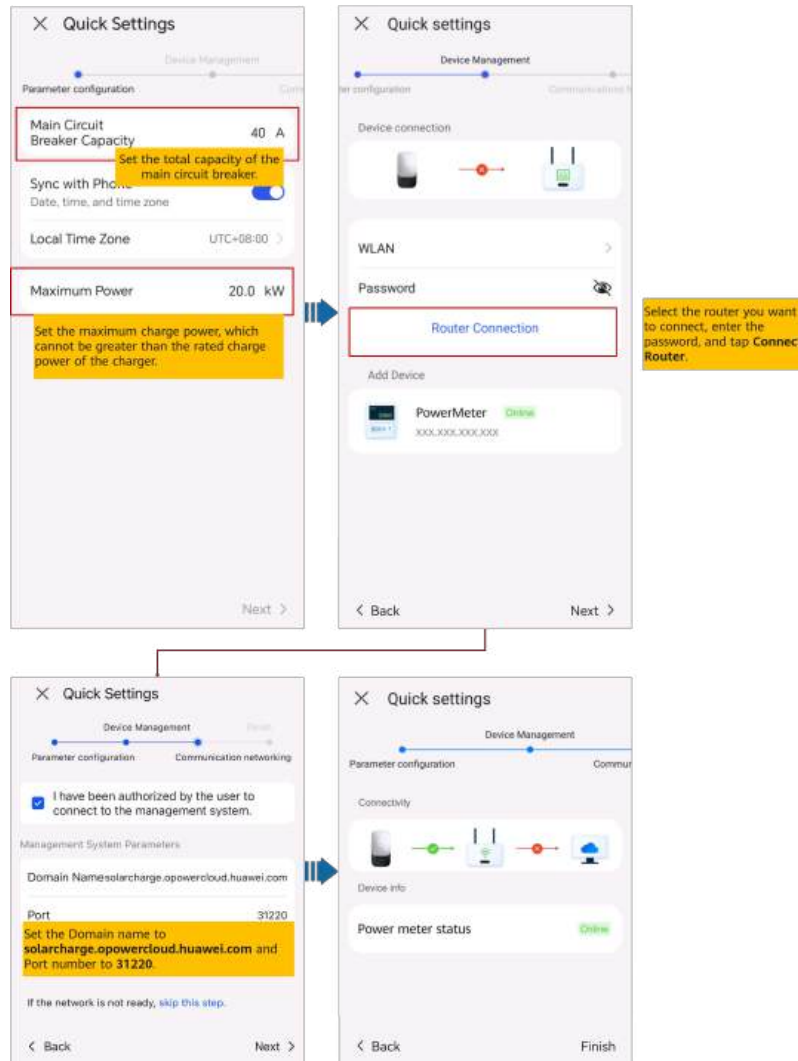

**NOTE**

Set the capacity of the main circuit breaker based on site requirements. If the set value is greater than the actual capacity, the circuit breaker trips due to overcurrent. If the set value is less than the actual capacity, the charger cannot work.

4. Tap **Finish** and connect devices to a plant as prompted. For details, see [6.1.4 Connecting to a Plant](#).

### 6.1.2.2 PV+ESS+Charger/ Charging-only (EMMA Scenario)

The charger can be connected to the same router as the EMMA over WLAN or FE. As one of the home loads, the charger is managed and controlled by the EMMA. After the deployment and commissioning on the EMMA side are complete, the charger can be connected to the management system. You do not need to perform deployment and commissioning on the charger separately.

For details about EMMA deployment and commissioning, see [FusionSolar App Quick Guide \(EMMA\)](#), or scan the QR code to obtain the corresponding quick guide.



**NOTE**

- If there is only one charger, it can be directly connected to the EMMA through the FE port or connected to the router through the FE or WLAN port.
- If there are two chargers, connect the FE ports of the two chargers to the router. Do not connect one charger to the router over wired network (FE) and the other charger over WLAN.

### 6.1.2.3 PV+ESS+Charger (Smart Dongle/Inverter WLAN Direct Connection Scenario)

The charger can implement dynamic power by connecting to the DTSU666-FE meter or the WLAN/FE Smart Dongle in the PV system through virtual meter networking to obtain RS485 meter detection data.

1. For details about PV+ESS device deployment and commissioning, see [FusionSolar App Quick Guide](#), or scan the QR code to obtain the corresponding quick guide.



**NOTE**

If a virtual meter is used for a charger, log in to the inverter connected to the Smart Dongle, choose **Settings > Communication configuration > Dongle parameter settings**, and set **Modbus TCP to Enable (unrestricted)**. If an FE meter is used, set **Modbus TCP to Disable**.



2. Commission the charger by referring to [6.1.2.1 Charging-only](#).
3. Connect the charger to the created PV plant by referring to [6.1.4 Connecting to a Plant](#).

### 6.1.3 Device Commissioning (PV+ESS)

For details, see the app commissioning video or *FusionSolar App Quick Guide*.

## Obtaining the Commissioning Video

Method 1: Visit the following link to obtain the commissioning video.

<https://support.huawei.com/enterprise/en/doc/EDOC1100165056>

Method 2: Scan the QR code below to obtain the commissioning video.



## Obtaining the Quick Guide

Method 1: Visit the following link to obtain the quick guide.

<https://support.huawei.com/enterprise/en/doc/EDOC1100165052>

Method 2: Scan the QR code below to obtain the quick guide.



## 6.1.4 Connecting to a Plant

After devices are commissioned, you can create a plant and configure basic information on the FusionSolar app to implement unified device monitoring and O&M.

- If the owner does not have a plant on FusionSolar SmartPVMS or FusionSolar app, see [6.1.4.1 Connecting to a New Plant](#) to connect the devices to a new plant.
- If the owner has a plant on FusionSolar SmartPVMS or FusionSolar app, see [6.1.4.2 Connecting to an Existing Plant](#) to connect the devices to an existing plant.
- If PV and energy storage devices and chargers are not provided by the same installer, see [6.1.4.3 Connecting Devices to a Plant with Multiple Installers](#) to connect them to a plant.

### 6.1.4.1 Connecting to a New Plant

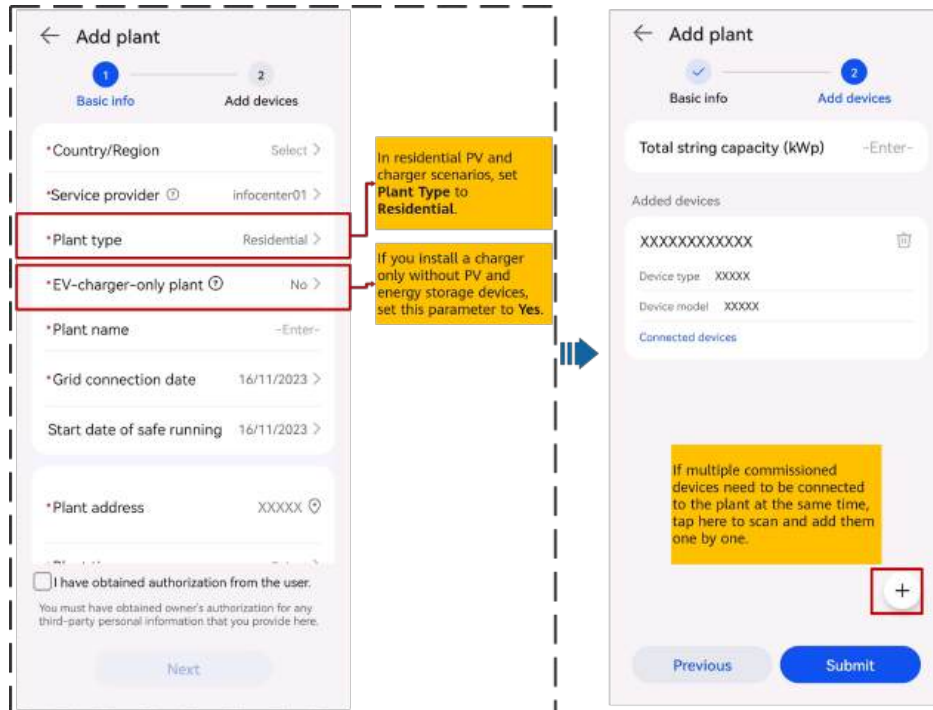

### 6.1.4.2 Connecting to an Existing Plant

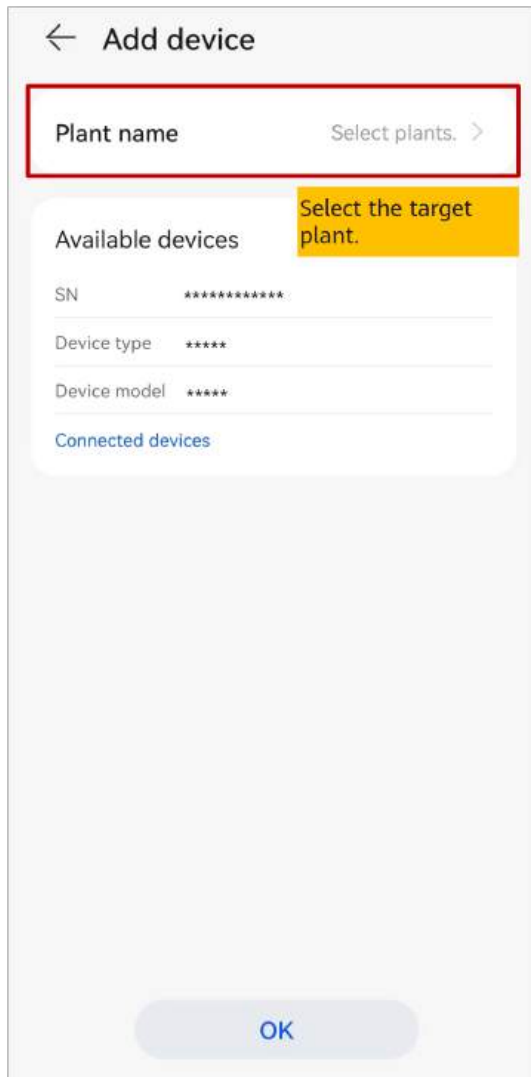

### 6.1.4.3 Connecting Devices to a Plant with Multiple Installers

#### Charging-Only Plant Created by Installer A and PV Devices Connected by Installer B

1. The owner logs in to the FusionSolar app and unbinds the charger from the plant created by installer A.
  - a. Choose **Me > Plant Management** and tap the target plant.
  - b. Tap **Add Devices**.
  - c. Tap  and select **Unbind Device** or **Delete Device** based on the site requirements.

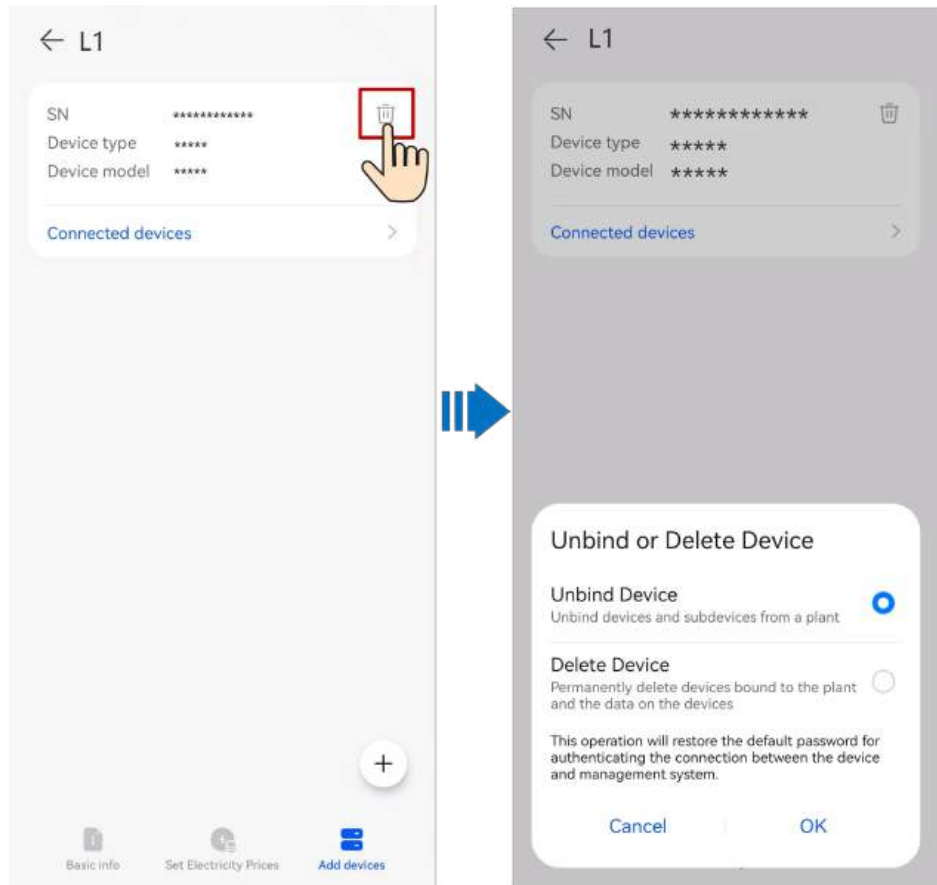

**NOTE**

- After a device is unbound, the running data of the device and its subdevices is stored in the database. The default data retention period is six months. To change the retention period, contact the system administrator.
  - If a device is rebound to a plant within the data retention period, the device inherits the retained data.
  - If a device is not bound to a plant within the data retention period, the data will be automatically deleted.
  - After a device is permanently deleted, the running data of the device and its subdevices is deleted immediately. When the device is bound to the plant again, the running data of the device is not restored.
2. Installer B connects the commissioned PV devices and charger to a new PV plant.

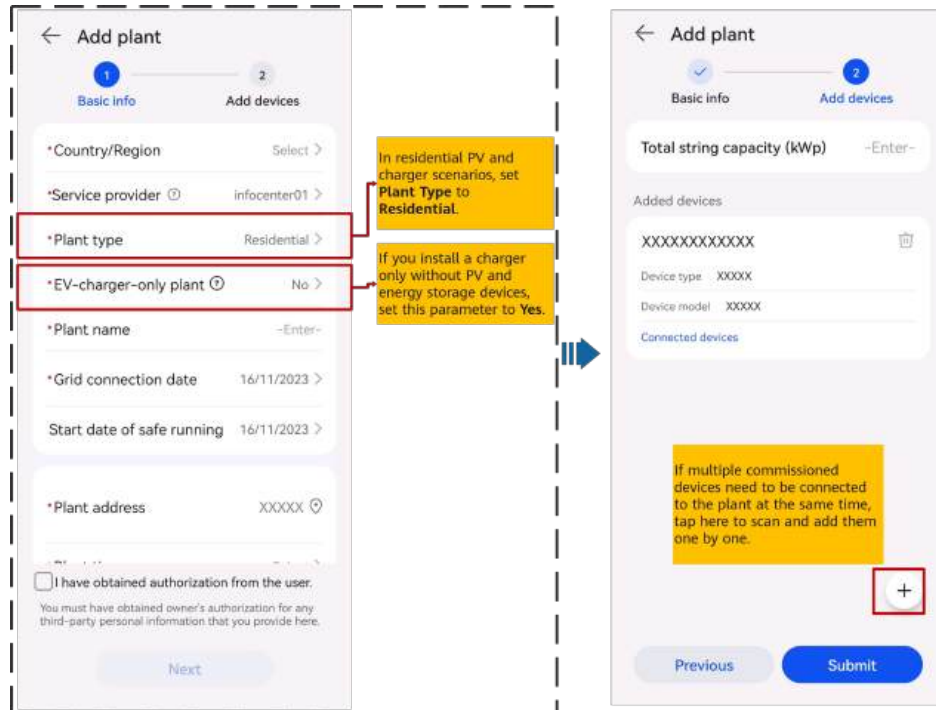

## PV Plant Created by Installer A and Charger Connected by Installer B

Installer B does not bind the charger to a plant after commissioning. The owner sends the SN or QR code of the charger to installer A, and installer A connects the charger to an existing PV plant.

1. Choose **Home > Plants**, and tap **Setup wizard**. Scan the QR code of the target charger.
2. On the plant creation screen, tap **Connect to existing plant**.
3. On the **Add Device** screen, select the target plant.
4. Tap **OK**.

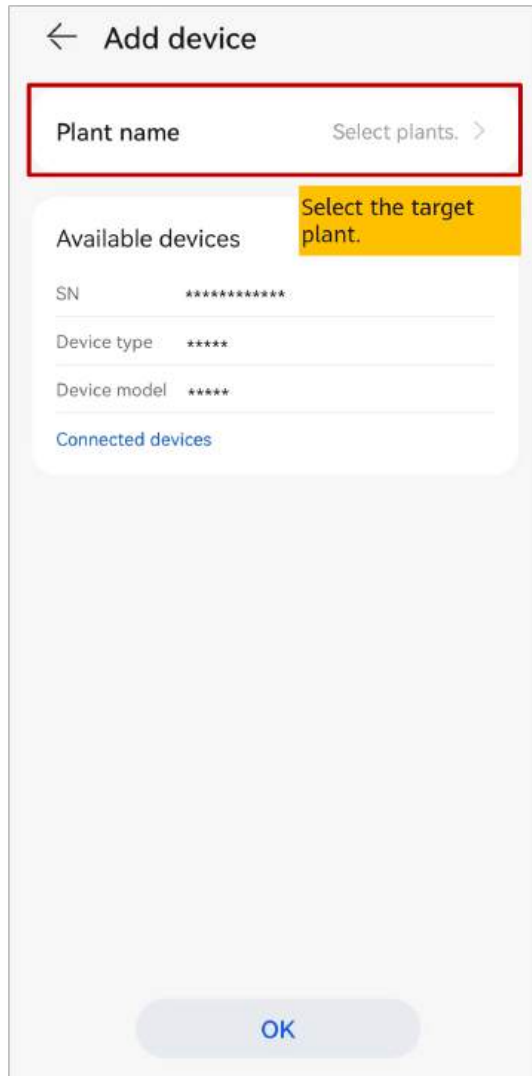

## 6.1.5 Adding a Device



After a plant is created, you can bind a new device to the plant.

### Prerequisites

- You have commissioned devices and set management system parameters using the local commissioning tool.
- If devices are connected to the management system through the SmartLogger or Smart Dongle, you need to enter the registration code of the SmartLogger or Smart Dongle when binding a plant. For details about how to obtain the registration code, see [10.14 How Do I Obtain a Registration Code?](#).

### Procedure

- Method 1: Add devices on the **Setup wizard** screen. (This method is recommended if only one device or a group of cascaded devices are connected at a time.)
  - a. Choose **Home > Plants**, and tap **Setup wizard**.

- b. Scan the QR code of the device to be connected.
- c. On the plant creation screen, tap **Connect to existing plant**.
- d. Select the plant to be connected.
- e. Tap **Confirm**.
- Method 2: Add devices on the **Add devices** screen. (This method is recommended if multiple devices or multiple groups of cascaded devices need to be connected.)
  - a. On the home screen of the app, choose **Me > Plant management**. In the plant list, tap the target plant.
  - b. Tap **Add devices**, and then tap .
  - c. Tap  to scan the QR code on the device to connect the device.
  - d. Tap **Save**.

----End

## 6.1.6 Setting the String Capacity

Configure the string capacity of a PV array to calculate the device operating efficiency.

1. On the home screen of the app, choose **Me > Plant management**. In the plant list, tap the target plant.
2. Tap **String capacity**.
3. Tap  in the upper right corner, select the device whose capacity needs to be set, and tap **Set String Capacity**.

### NOTE

You can select inverters of the same model or string capacity and set the string capacity.

4. Set the PV string capacity as prompted.

## 6.1.7 Setting Electricity Prices (Simple Price)

Configure the time-of-use electricity prices to calculate the revenue based on different electricity prices in different time segments so that the calculation is more accurate.

1. On the home screen of the app, choose **Me > Plant management**. In the plant list, tap the target plant.
2. Tap **Set Electricity Prices**.
3. Tap  in the upper right corner and set **Purchase price** and **Feed-in tariff** as prompted.

## 6.1.8 Set Electricity Prices (Compound Price)

### 6.1.8.1 Purpose

FusionSolar Smart PV Management System (SmartPVMS) can calculate the PV plant benefit based on the electricity price information set by users. The PV plant benefit consists of the revenue of power fed to the grid (feed-in power x feed-in tariff) and savings on electricity bills (self-supplied power x purchase price).

- Feed-in tariff: indicates the unit price of PV power fed to the grid.
- Purchase price: indicates the unit price of electricity purchased from the grid when the PV power is insufficient.

### 6.1.8.2 Setting the Feed-in Tariff

1. Choose **Me > Plant management** on the home screen of the app and tap the target plant in the plant list.
2. Choose **Set Electricity Prices > Feed-in tariff**.
3. Set the time segment and enter the feed-in tariff in the time segment.  
If the feed-in tariff varies based on time segments or date periods, you can tap **Add Time Segment** and **Add date period** to set multiple time segments and date periods.

### 6.1.8.3 Configuring a Purchase Price

---

#### NOTICE

Before configuration, set the correct country/region where the plant is located and the correct plant type. Otherwise, the system cannot push the electricity price template of the target country/region.

1. Choose **Me > Plant management** on the home screen of the app and tap the target plant in the plant list.
2. Choose **Set Electricity Prices > Purchase price**.
3. After selecting a template, configure the electricity price as prompted.  
For more details about configuration, see [6.1.8.4 Example of Configuring an Electricity Price](#).

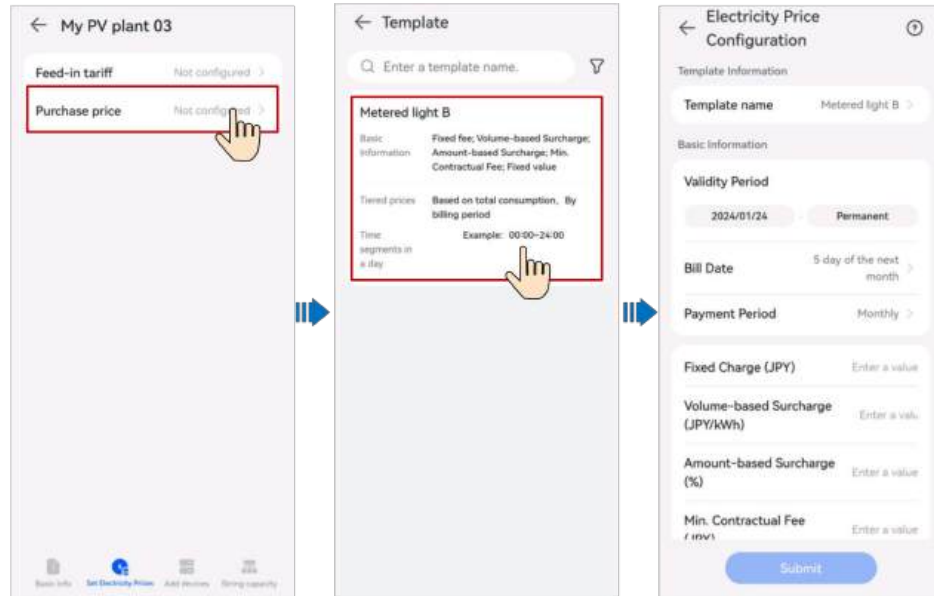

**NOTE**

- Select an appropriate electricity price template based on the electricity fee calculation method in the purchase contract signed with the electric power company.
- If the electricity price calculation method in the available electricity price template is different from that in the purchase contract, contact the installer to add a template.

### 6.1.8.4 Example of Configuring an Electricity Price

#### 6.1.8.4.1 Example of Configuring an Electricity Price (Scenario 1)

Keywords: TOU pricing, tiered pricing

1. **Table 6-2** is used as an example to obtain the following information by analyzing the electricity price solution:
  - The electricity price changes with time segments in a day.
  - The current electricity price depends on the electricity consumption. The tiered pricing is adopted for all time segments in a day.

**Table 6-2** Residential electricity price list 1

Price Type		Unit Price (CNY/kW)
Tier 1 (0-260 kW)	Peak hours	1
	Shoulder hours	0.65
	Off-peak hours	0.35
Tier 2 (261-600 kW)	Peak hours	1.2
	Shoulder hours	0.7
	Off-peak hours	0.4

Tier 3 (> 601 kW)	Peak hours	1.3
	Shoulder hours	0.95
	Off-peak hours	0.6
<p>Note:</p> <ul style="list-style-type: none"> <li>• Peak hours (14:00–17:00; 19:00–22:00)</li> <li>• Shoulder hours (8:00–14:00; 17:00–19:00; 22:00–24:00)</li> <li>• Off-peak hours (00:00–8:00)</li> <li>• For tiered pricing, the total volume of electricity consumption will be reset monthly. The data of one month will not be carried over to the next month.</li> </ul>		

2. Filter out the electricity price template based on the analysis result in [Step 1](#).

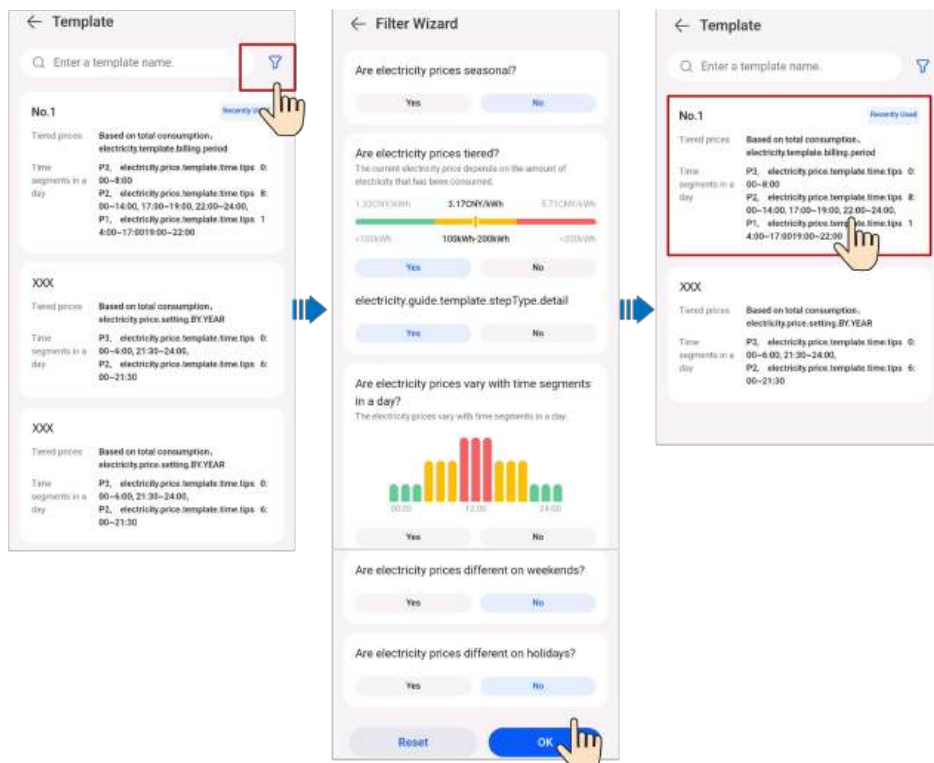

3. After the template is selected, fill in the electricity price information according to the contract.

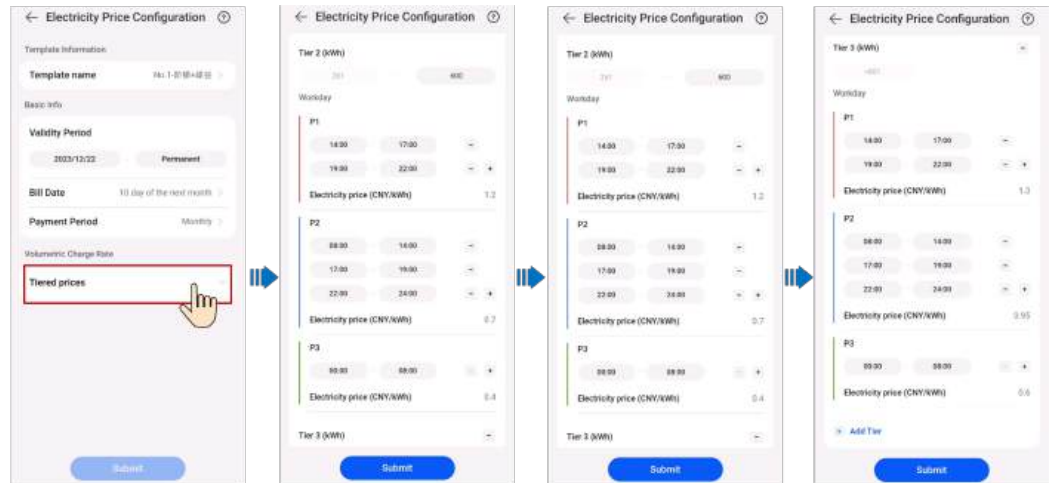

### 6.1.8.4.2 Example of Configuring an Electricity Price (Scenario 2)

Keywords: pricing by season, tiered pricing, extra fee based on volumetric charge, min. contract fee

1. **Table 6-3** is used as an example to obtain the following information by analyzing the electricity price solution:
  - The electricity price varies with seasons.
  - The current electricity price depends on the electricity consumption. The tiered pricing is adopted for all time segments in a day.

**Table 6-3** Residential electricity price list 2

Price Type	Unit Price	
Basic fee	60 (A)	1700 JPY/month
Volumetric charge rate (summer)	Tier 1 (0-120 kWh)	30 JPY/kW
	Tier 2 (121-300 kWh)	36 JPY/kW
	Tier 3 (> 301 kWh)	40 JPY/kW
Volumetric charge rate (other seasons)	Tier 1 (0-120 kWh)	25 JPY/kW
	Tier 2 (121-300 kWh)	28 JPY/kW
	Tier 3 (> 301 kWh)	35 JPY/kW
Minimum monthly fee	320 JPY	
Fuel cost adjustment	-	6 JPY/kW
Renewable energy regulation	-	3 JPY/kW

Price Type	Unit Price
<p>Note:</p> <ul style="list-style-type: none"> <li>• Summer: May to October</li> <li>• Other seasons: January to April, November, and December</li> <li>• For tiered pricing, the total volume of electricity consumption will be reset monthly. The data of one month will not be carried over to the next month.</li> </ul>	

2. After selecting a template based on the analysis result in Step 1, fill in the electricity price information based on the contract.

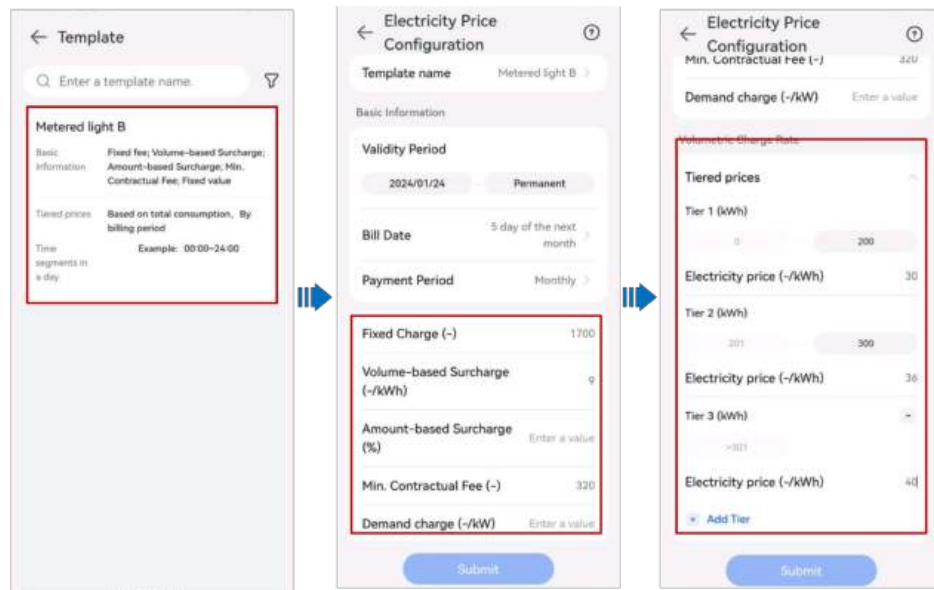

## 6.1.8.5 More Operations

### 6.1.8.5.1 Applying the Purchase Prices to Other Plants

1. Choose **Me > Plant management** on the home screen of the app and tap the target plant in the plant list.
2. Choose **Set Electricity Prices > Purchase price**.
3. Select the target electricity price and choose : > **Apply to Other Plants**.
4. Select the target plant and apply the price configuration to the plant as prompted.

### 6.1.8.5.2 Setting Holidays

Log in to the [FusionSolar SmartPVMS](#), choose **Plants > System Configuration > Set Holidays**, and set the parameters as prompted.

### 6.1.8.5.3 Adding a Purchase Price Template

Only installers can add purchase price templates. Log in to the [FusionSolar SmartPVMS](#) and choose **Plants > System Configuration > Set Electricity Prices** to add templates as prompted.

## 6.1.9 Creating a Physical Location Layout

### 6.1.9.1 Automatically Generating a Physical Layout

After an optimizer is installed, you can attach the optimizer SN label to the physical layout template and use the image recognition to quickly create a physical layout.

#### NOTE

- If there are more than 16 photos of the physical layout templates, go to the FusionSolar SmartPVMS to upload the photos.
- A maximum of 200 PV modules can be added on the current tab page. If the number of PV modules exceeds 200, go to the FusionSolar SmartPVMS to create a physical layout.

### Procedure

1. On the app login screen, enter the installer account and password and tap **Log in**.

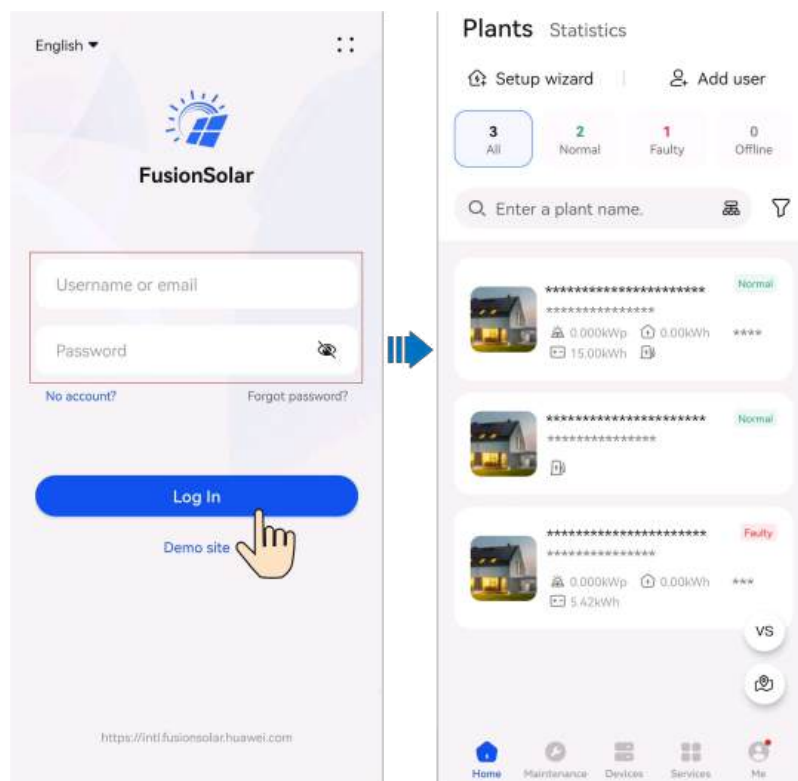

2. Choose **Home > Plants**. Tap the plant that has been connected to the optimizers.
3. , choose **Layout > Physical layout**, tap , and upload the physical layout drawing as prompted.

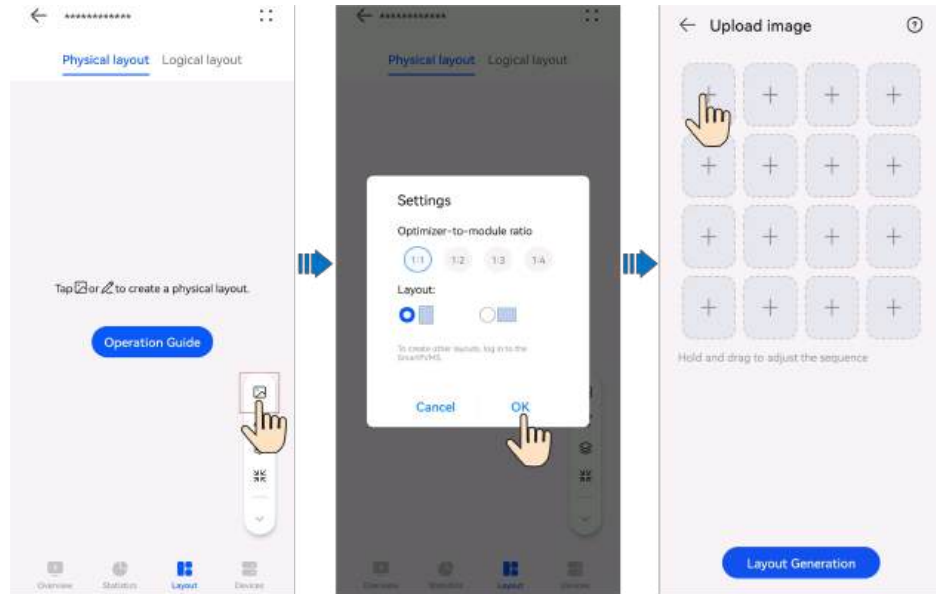

**NOTE**

For the first identification, set **Optimizer-to-module ratio** and **Layout** based on the actual optimizer installation.

4. After all drawings are uploaded, tap **Generate Physical Layout** to generate the physical layout, and confirm the identification result.

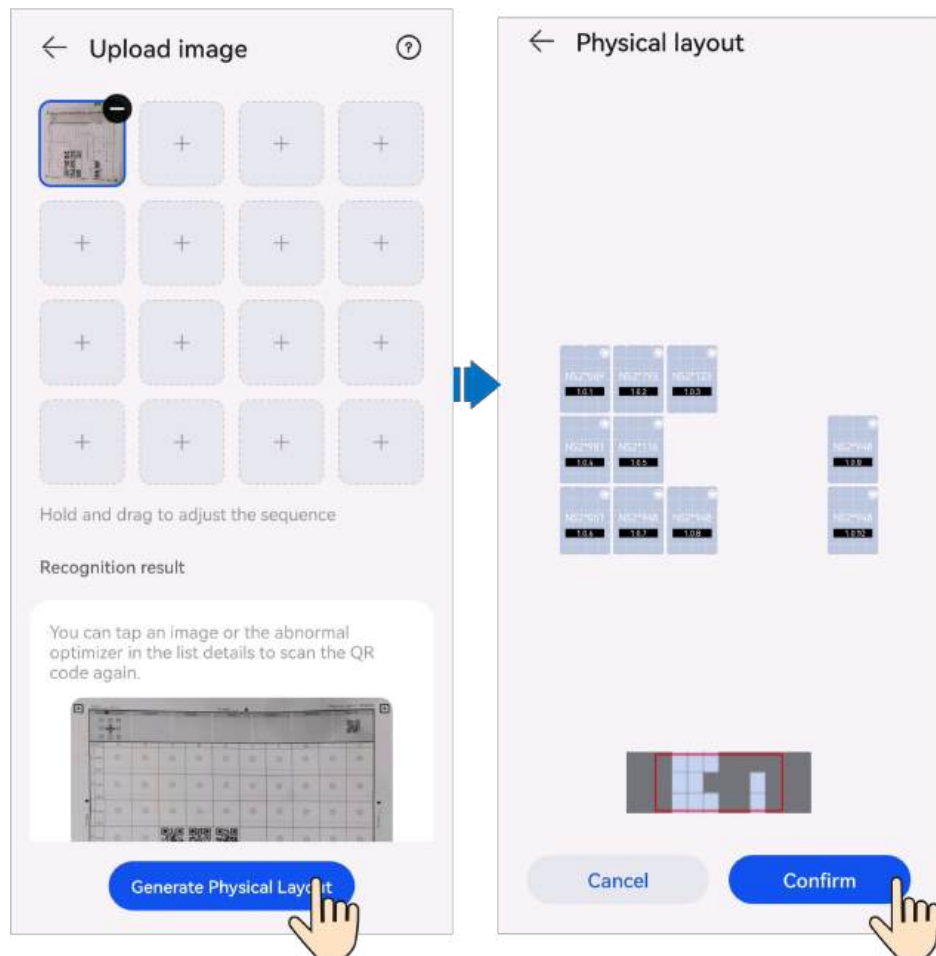

5. Tap **OK** to save the physical layout.

 **NOTE**

- If some QR codes cannot be identified, manually bind optimizers and inverters by referring to [Binding Optimizers and Inverters](#).
- After a physical layout is generated, you can view the physical location, status, and energy yield of each optimizer. For details, see [6.1.9.4 Viewing a Physical Layout](#).

## 6.1.9.2 Manually Creating a Physical Layout

You can manually create a physical layout by adding inverters and PV modules and binding PV modules to optimizers.

### Adding Inverters and PV Modules

1. On the app login screen, enter the account and password and tap **Log In**.

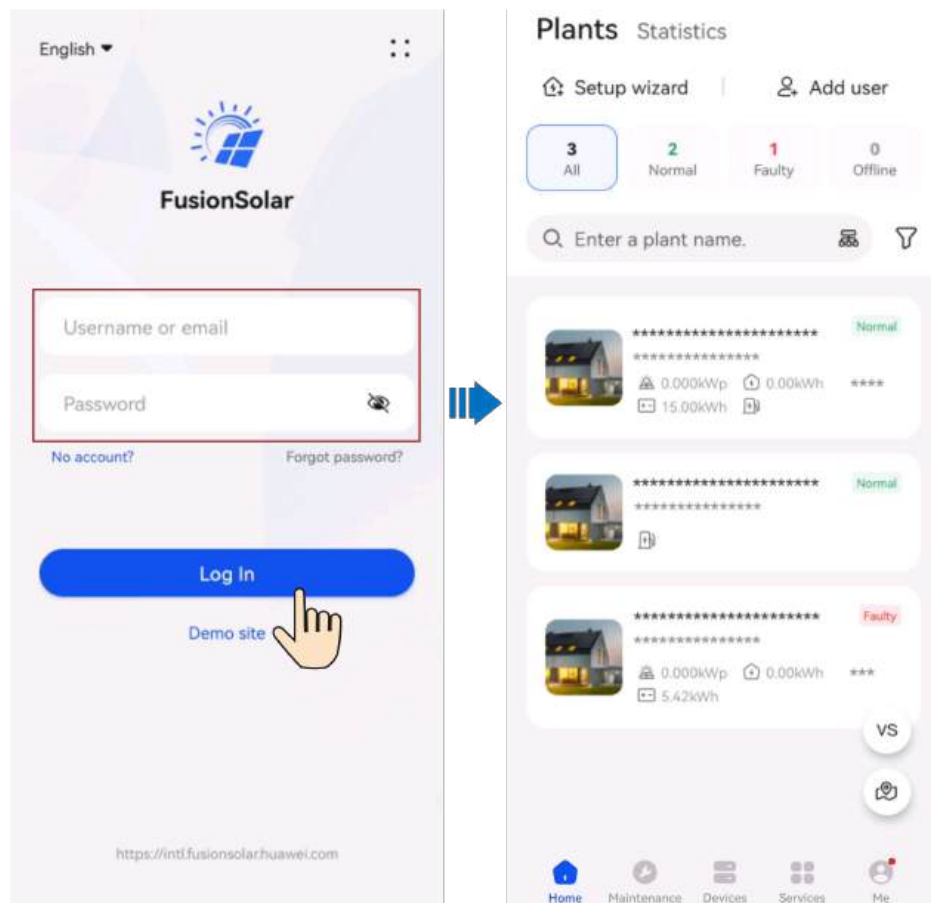

2. Choose **Home > Plants**. Tap the plant that has been connected to the optimizers.
3. Choose **Layout > Physical layout** and tap .

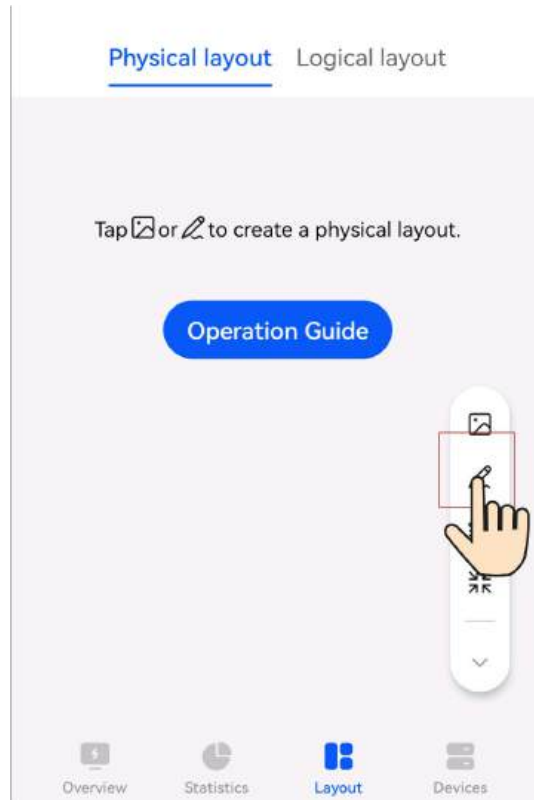



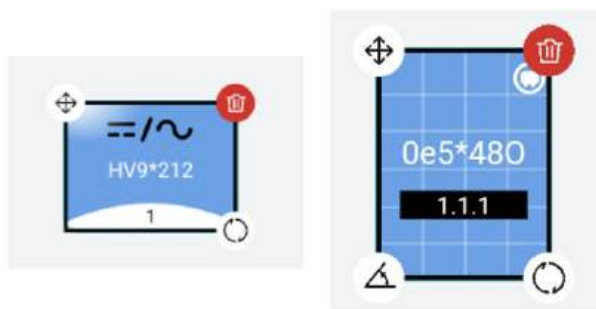

4. Tap the blank area to add inverters and PV modules.
5. Tap  to save the settings.

### Adjusting the Position and Angle of an Inverter or PV Module

Tap an inverter or PV module, adjust the position and angle of the inverter or PV module, and tap  to save the settings.





Function	Operation
Adjusting the position	Press and hold  to move an inverter or PV module to an appropriate position.
Adjusting the azimuth	Press and hold  to move or tap  to enter the azimuth.

Function	Operation
Adjusting the tilt angle	Tap  and enter the tilt angle of a PV module.
Deleting an inverter or PV module	Tap  to delete an inverter or PV module.

## Binding Optimizers and Inverters

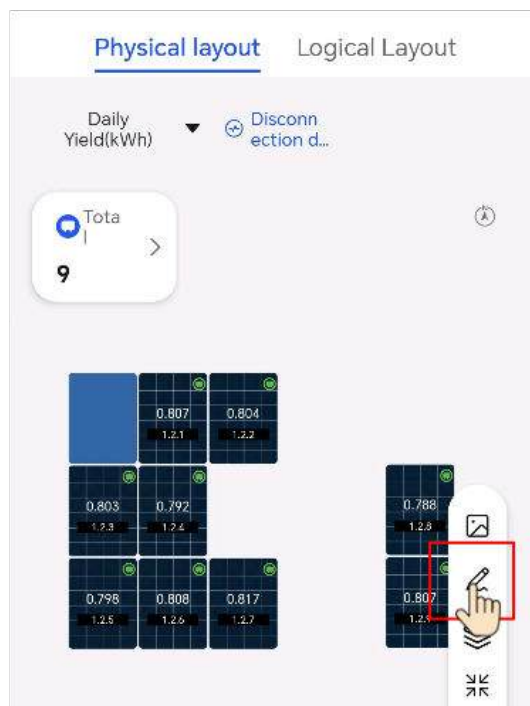
1. Tap a plant that has been connected to optimizers, choose **Layout > Physical layout**, and tap .



2. Click  to scan the SN label of an optimizer or inverter, or manually select the target optimizer or inverter to be bound.
  - Method 1: Scan the SN labels of the optimizer or inverter.  
Tap a PV module, scan the SN label of an optimizer to bind them together; or tap an inverter, scan the SN label of another inverter to bind them together.

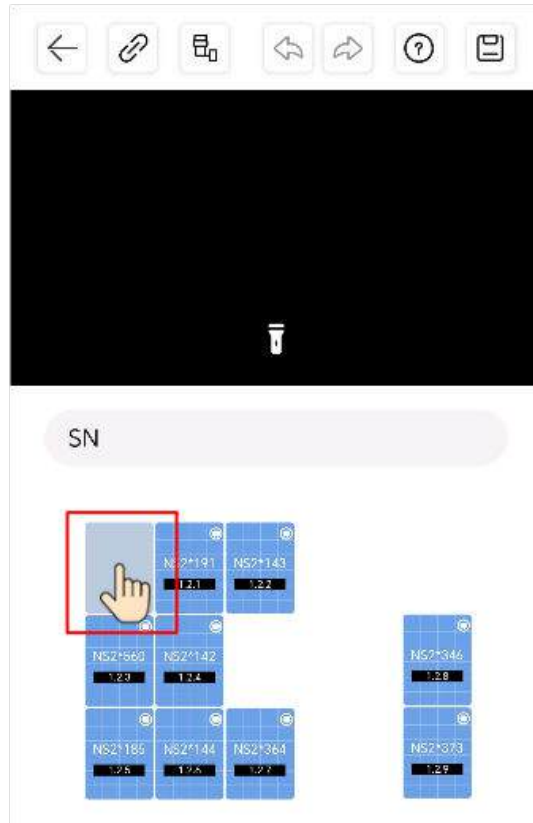

**NOTE**



indicates the 1:1 scenario where one optimizer is bound to one PV module.



indicates the 1:2 scenario where one optimizer is bound to two PV modules and you need to tap two PV modules before scanning the SN label of an optimizer.

- Method 2: Manually select an optimizer or inverter.

Tap  and then tap a PV module to bind it to an optimizer; or tap an inverter to bind it to another inverter.

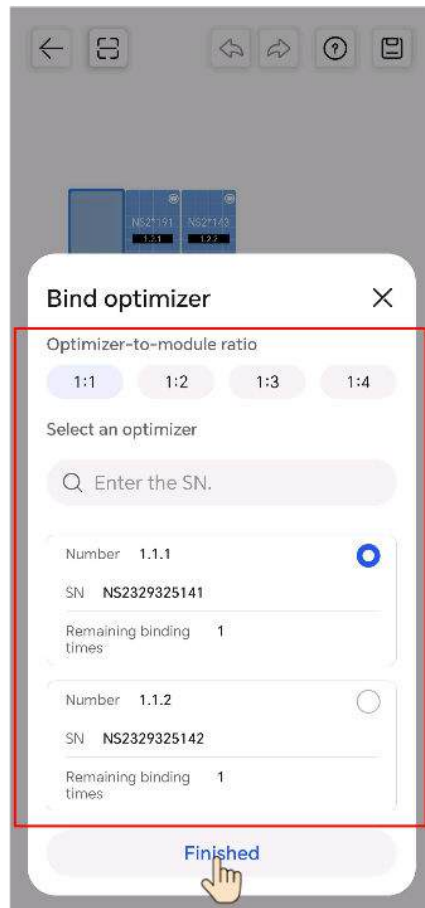

3. Tap  to save the settings.

### 6.1.9.3 Binding Optimizers and Inverters

1. Tap a plant that has been connected to optimizers, choose **Layout > Physical layout**, and tap .

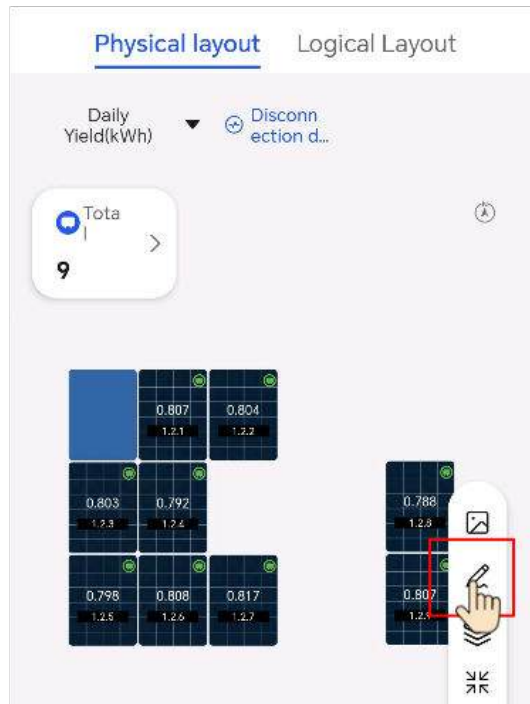

2. Click  to scan the SN label of an optimizer or inverter, or manually select the target optimizer or inverter to be bound.
  - Method 1: Scan the SN labels of the optimizer or inverter.  
Tap a PV module, scan the SN label of an optimizer to bind them together; or tap an inverter, scan the SN label of another inverter to bind them together.

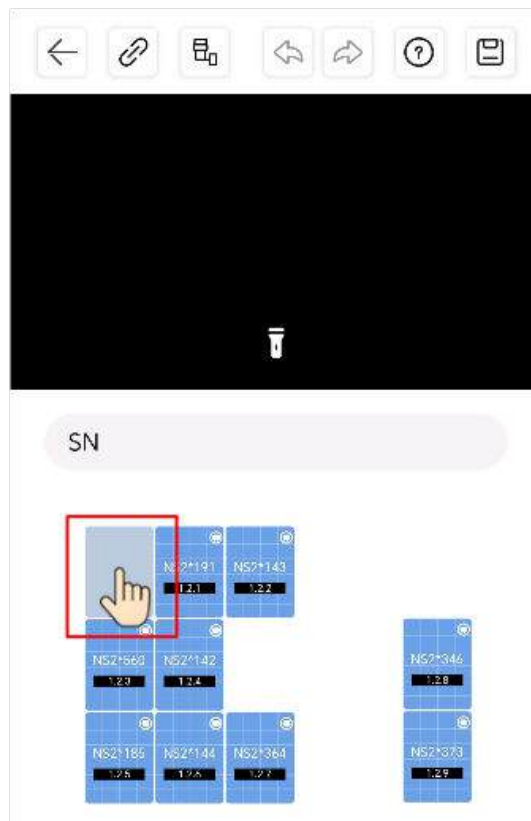

 NOTE



indicates the 1:1 scenario where one optimizer is bound to one PV module.



indicates the 1:2 scenario where one optimizer is bound to two PV modules and you need to tap two PV modules before scanning the SN label of an optimizer.

- Method 2: Manually select an optimizer or inverter.

Tap  and then tap a PV module to bind it to an optimizer; or tap an inverter to bind it to another inverter.

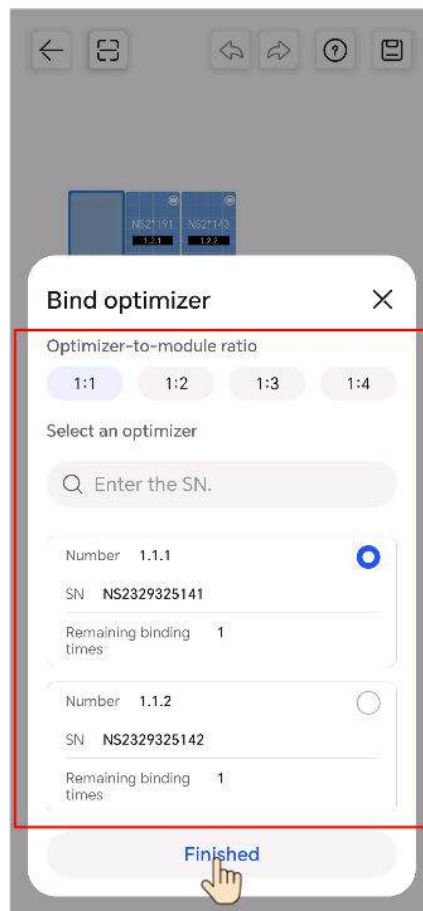

3. Tap  to save the settings.

### 6.1.9.4 Viewing a Physical Layout

#### Viewing a Physical Layout

1. On the **Home** screen, tap **Plants** and tap the desired plant.
2. Tap **Layout**.
3. On the **Physical layout** screen, view related information.
  - **Figure 6-4** shows the screen description.

**Figure 6-4** Screen description

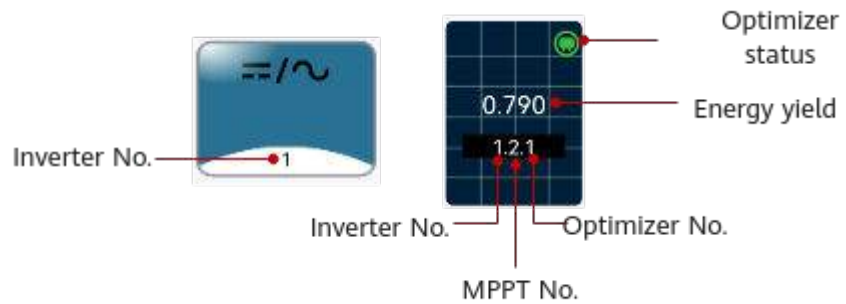

- Optimizer status

Icon				
Status	Normal	Faulty	Offline	Disconnecte d

- PV module color

The color of a PV module indicates the ratio of the optimizer output power to the rated optimizer power. The following figure shows the mapping.





- Viewing details: Tap an optimizer to view information such as the energy yield, output power, and output voltage.
- Displaying energy yield in different dimensions: Tap **Daily Yield(kWh)** in the upper left corner to display the energy yield of the current day, current month, or current year, or accumulated energy yield.
- Zooming in, zooming out, or restoring the view: Press and hold the screen with two fingers to zoom in or zoom out the view. Tap to restore the view to the normal size.

## 6.2 Plant Overview

The FusionSolar app provides an overview of plants. You can view the plant running status, energy yield and consumption, revenue, and energy flow diagram in real time.

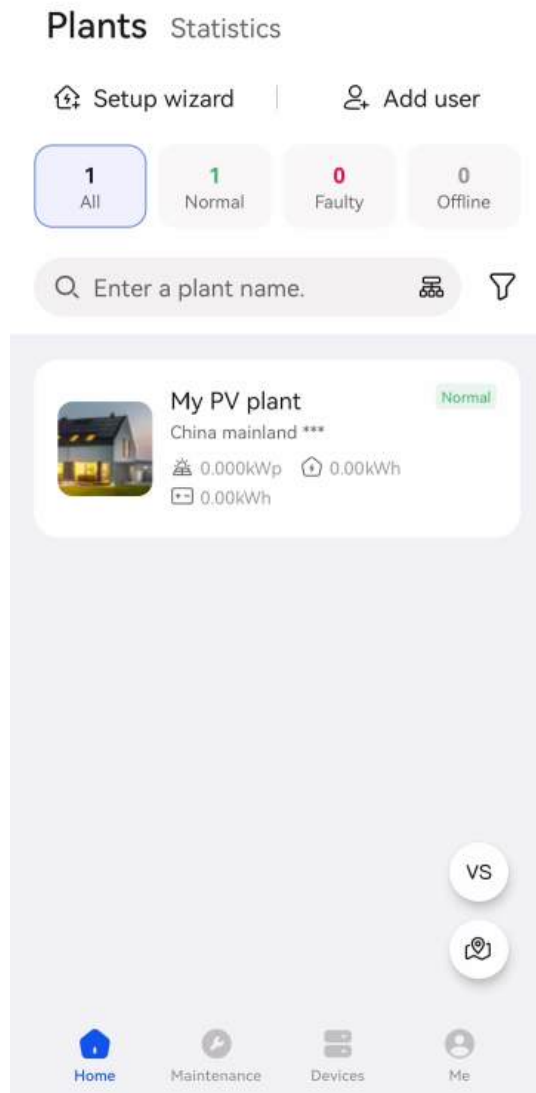
Log in to the app, tap **Home**, and tap **Plants**. This screen displays the real-time running status and basic information of all plants managed by the user by default.



- Tap  to compare plants in the same environment to evaluate their energy yield efficiency.
- Tap  to switch to the map view and display the geographical distribution and alarm statistics of the plant.
- Tap the target plant to view the plant overview.

## 6.2.1 Viewing Status of a Charging-only Plant

The FusionSolar app provides an overview of plants. You can view the plant running status, energy yield and consumption, revenue, and energy flow diagram in real time.

### Viewing Plant Overview

Log in to the app, choose **Home** > **Plants**, and tap a charging-only plant to view the charger status.

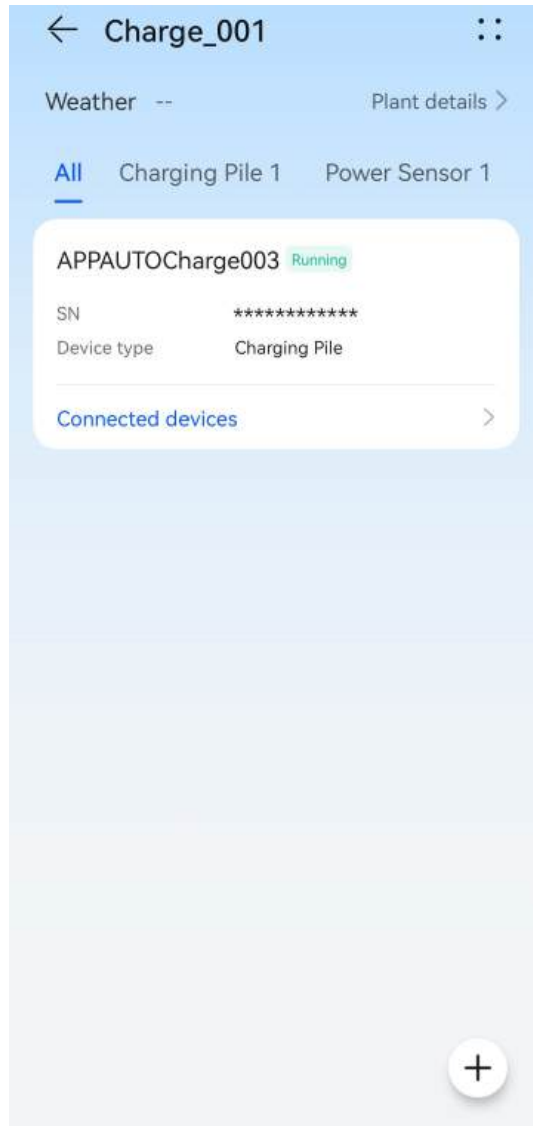

Tap the target charger to view its real-time information, alarm information, and device information, and set the charger parameters.

## Viewing Real-Time Information

On the **Real-time info** screen, view key running parameters such as the device running status and total charge energy.

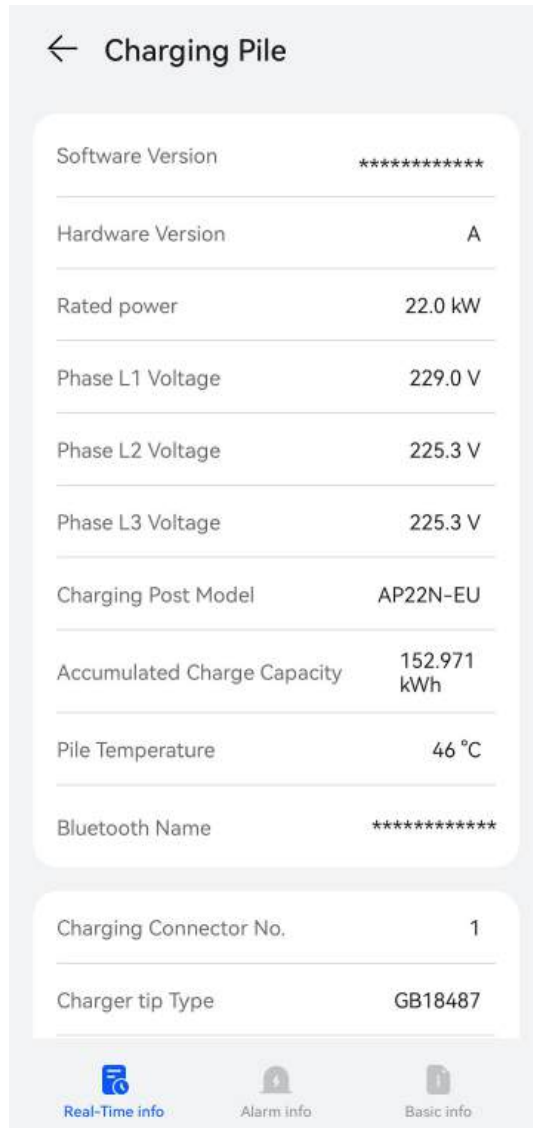

**NOTE**

The displayed parameters vary with the software version.

## Viewing Alarm Information

On the **Alarm info** screen, view the active alarms of the plant. Tap an alarm to view its details.

You can clear the alarm based on the alarm cause and handling suggestions.

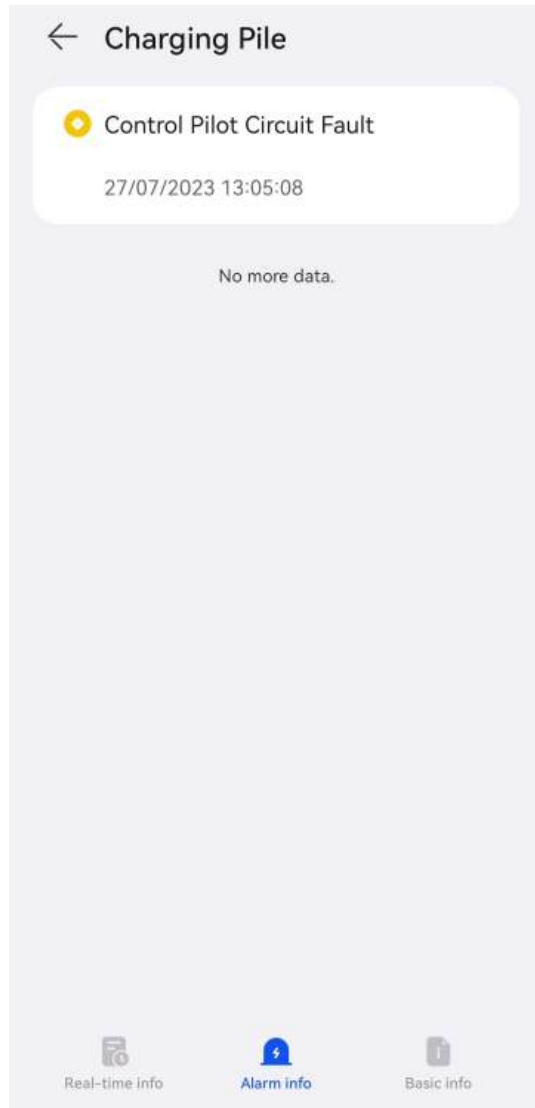

## Viewing Device Information

On the **Basic info** screen, view basic information such as the device type and software version.

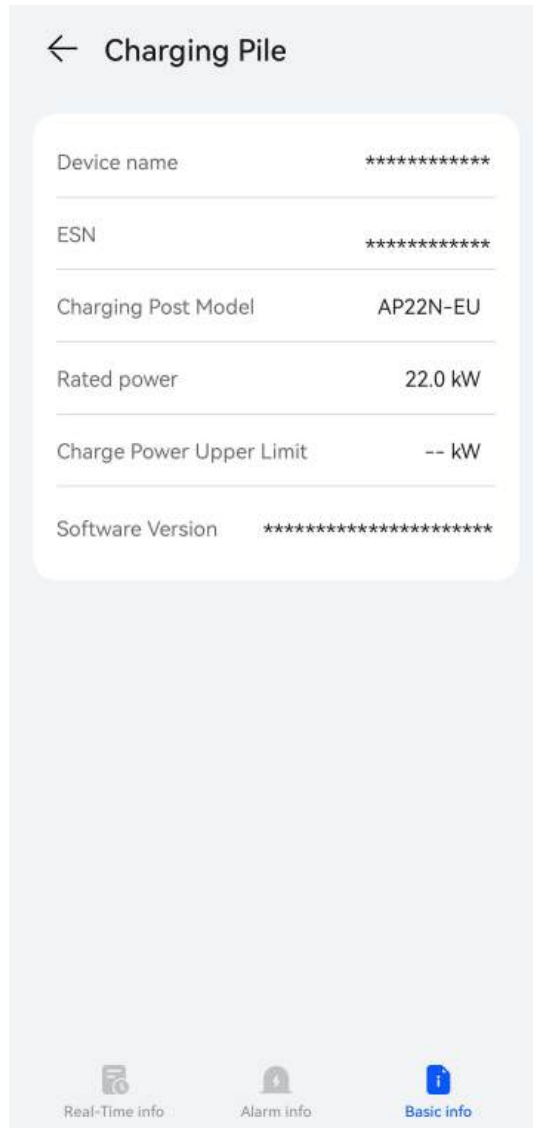

**NOTE**

The displayed parameters vary with the software version.

## 6.2.2 Viewing Status of a PV+ESS+Charger Plant

The FusionSolar app provides an overview of plants. You can view the plant running status, energy yield and consumption, revenue, and energy flow diagram in real time.

### Viewing Plant Overview

Log in to the app and tap **Home > Plants**. Tap a desired plant to check its overview. The plant overview includes the basic plant information, energy yield and revenue statistics, real-time running status, and energy flow diagram.

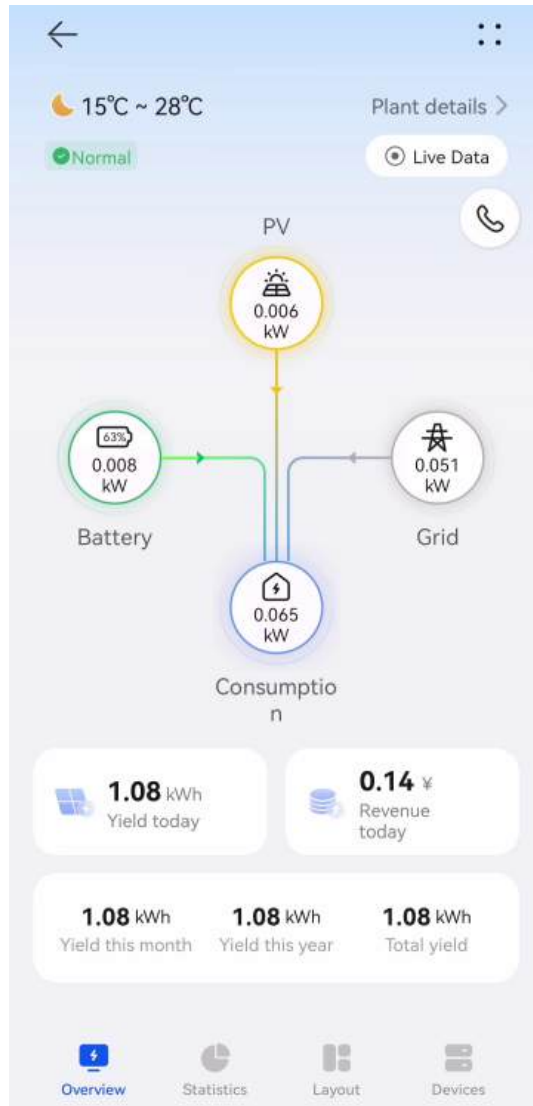

- Weather information: Displays the weather information of the place where the plant is located on the current day. You can tap **Plant details** to view the detailed plant information.
- Energy yield and revenue statistics: Displays the energy yield and revenue of the plant.
- Real-time running status: Allows you to check whether the current running status of the plant is normal.
- Energy flow diagram: Displays the current power supply direction of the plant.
- You can click **Live Data** to update the real-time data of the PV power, grid power, load power, and ESS power.

**NOTE**

- By default, the function is enabled for 1 minute each time. The function can be enabled for a maximum of 10 times (total times on the WebUI and app) per plant per day.
- After the function is enabled in the 4G networking scenario, a maximum of 3 MB traffic data will be consumed each month (assuming that the function is enabled 10 times per day).

If a plant has active alarms, the latest alarm information is displayed above the energy flow diagram. You can tap  on the right of the alarm information to view and handle all active alarms of the plant.

## Viewing Plant Statistics

Tap the **Statistics** tab to view the energy yield, energy consumption, revenue, and environmental benefits of a plant.



- **Energy management:** Displays the energy yield, energy consumption, and self-consumption of a plant in different time dimensions, helping you analyze and optimize energy consumption. When an ESS is available, it stores and discharges energy, improving the self-consumption rate.
- **Revenue statistics:** Calculate the sum of feed-in revenue of a PV plant (feed-in electricity x feed-in tariff) and savings in electricity bills (self-consumed electricity x purchase price) to display the benefits created by the PV plant.
- **Environmental benefits:** Unlike thermal power plants, PV power plants generate electricity without CO<sub>2</sub> emissions, which is equivalent to planting

trees. For details, see [11.1 PV Power Generation Offsetting Carbon Emissions](#).

## 6.2.3 Viewing EMMA Revenue and Energy Forecast

The AI Energy Management Assistant (EMMA) provides intelligent energy scheduling and management functions. Based on big data analysis, it accurately predicts the power generation and consumption curves of households, and intelligently stores, purchases, and sells electricity to achieve optimal system performance, improve the utilization rate of PV power, and maximize financial benefits.

### Prerequisites

The owner has enabled the EMMA function for the plant.

### Viewing the Revenue After EMMA Was Enabled and Energy Forecast

1. On the **Overview** screen, choose **> EMMA** in the upper right corner to view the revenue information, revenue comparison, and energy forecast.
  - Viewing the revenue comparison: In the **Revenue Comparison** area, you can view the comparison between the revenues when EMMA is enabled and disabled.
  - Viewing energy forecast: In the **Energy Forecast** area, you can view details about the energy yield, power consumption, and battery charge and discharge in the past 24 hours, and energy forecast in the next 24 hours.

## 6.2.4 Optimizer Disconnection Detection

Perform disconnection detection on optimizers and locate the disconnected optimizers.

### Procedure

**Step 1** On the **Home** screen, tap **Plants** and tap the desired plant.

**Step 2** Tap **Layout**. If no physical layout diagram is created for the plant, the logical layout screen is displayed.

**Step 3** On the logical layout screen, tap **Disconnection detection**.

- If multiple inverters are installed in the plant and all of them are equipped with optimizers, select the inverter to be detected in the dialog box that is displayed and tap **OK**.
- If only one inverter in the plant is equipped with an optimizer, the detection task is directly executed after you tap **Disconnection detection**.

**Step 4** If a disconnected optimizer is detected, you can quickly locate the optimizer in the physical layout diagram and rectify the fault based on the repair suggestions.

----End

## Follow-up Procedure

After the disconnection fault is rectified, perform the disconnection detection again to ensure that the fault is rectified.

## 6.3 O&M Management

You can learn about the running status, location distribution, and alarm information of plants, and quickly track and handle plant faults.

### 6.3.1 Monitoring Alarm Information

You can monitor active alarms that are updated in real time to learn about the latest alarm status and handle alarms.

#### Viewing Alarm Information

1. Tap **Maintenance** on the home screen, and then tap the **Alarms** tab to view active alarms of all plants that you have permission to manage.

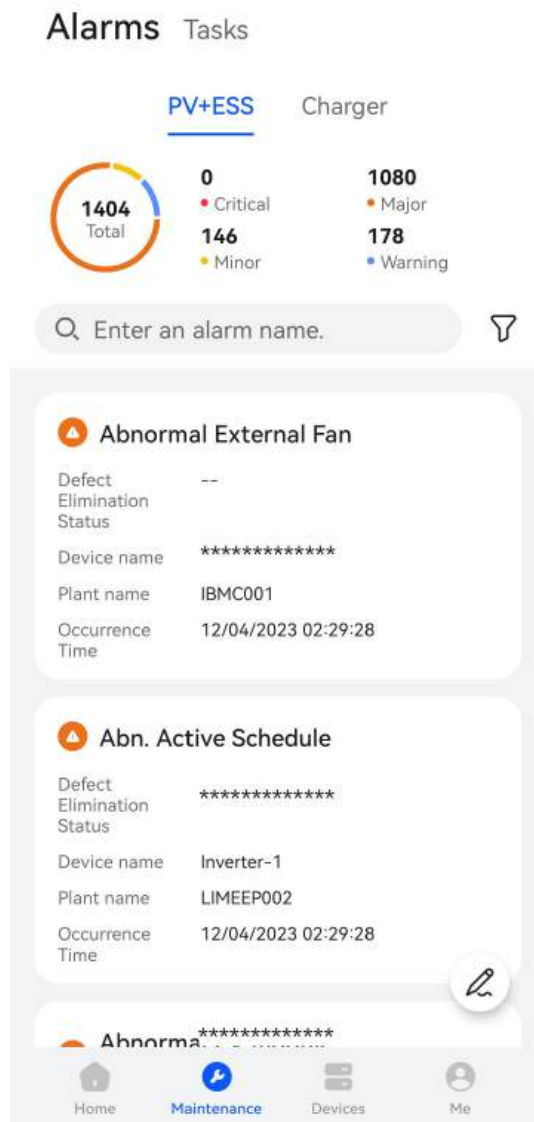

## Handling Alarms

On the **Alarms** screen, tap an alarm to view its details.

You can create a ticket for, acknowledge, or clear an alarm based on the alarm cause and handling suggestions in the alarm details.

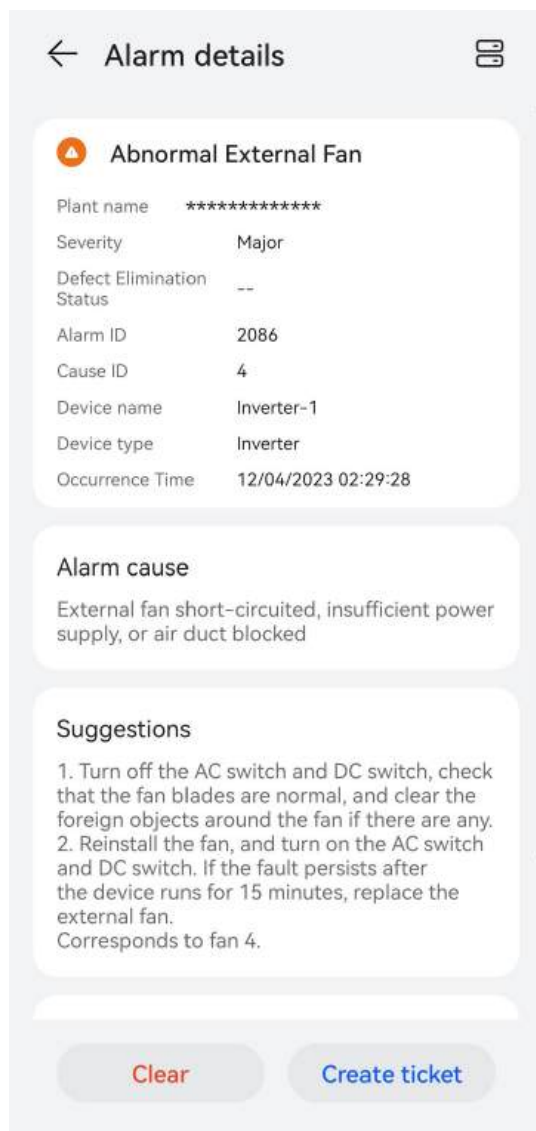

**Table 6-4** Alarm handling

Operation	Description
New ticket	Record, track, and monitor the faults or defects that have occurred, and manage them using defect elimination tickets. If a defect elimination ticket has been created for the alarm, this button is not displayed.
Clear	If a fault is rectified but the alarm is not automatically cleared, tap <b>Clear</b> to manually clear the alarm.

 NOTE

- Charger alarms cannot be handled through defect elimination tickets.
- If a defect elimination ticket has been created for an alarm, you can [track and process the defect elimination task](#) on the **Tasks > Elimination tasks** screen.

## 6.3.2 Mobile O&M

Create tasks to perform routine inspection on plant equipment, identify risks, and track and monitor faults or defects that have occurred.

### 6.3.2.1 Defect Elimination

You can record, track, and monitor the faults or defects that have occurred to eliminate them in a timely manner.

#### Creating a Defect Elimination Task

1. On the home screen, choose **Maintenance > Tasks**.
2. Tap . The **Task Management** screen is displayed.
3. Tap + in the upper right corner and select **Defect elimination**.
4. Fill in the ticket information as prompted and submit it.

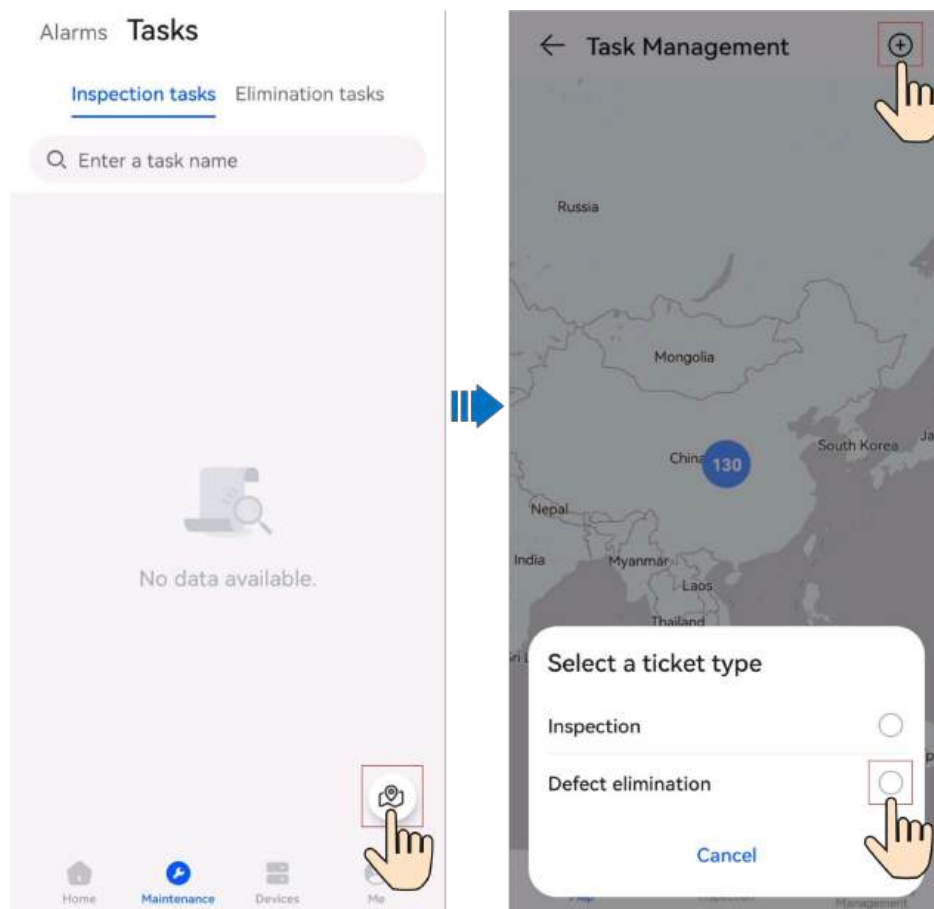

## Processing a Defect Elimination Task

1. On the home screen, choose **Maintenance** > **Tasks** > **Elimination tasks**.
2. On the **Elimination tasks** screen, view and process defect elimination tasks.

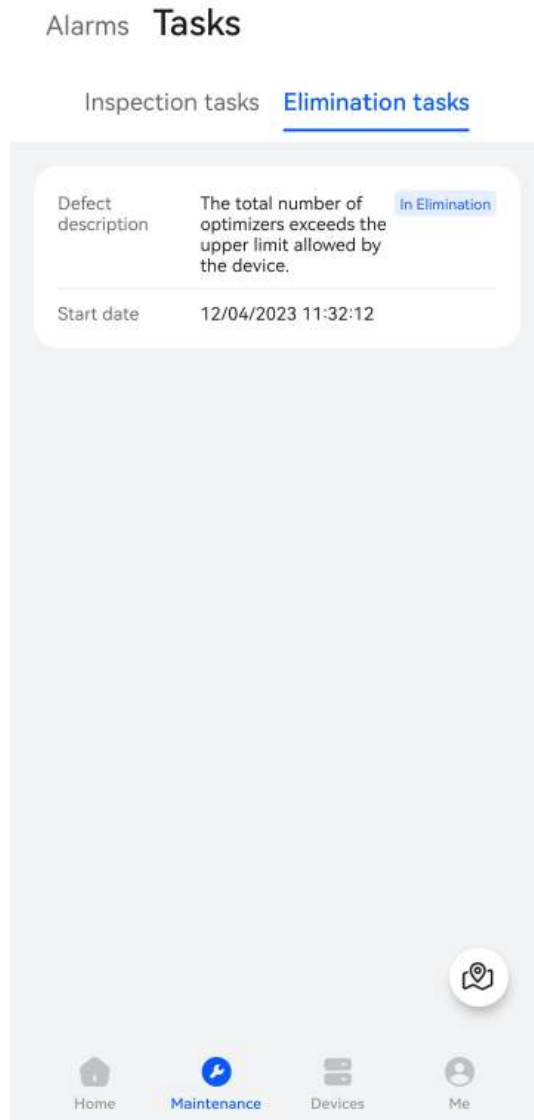

**Table 6-5** Defect elimination task status description

Task Status	Description
To be dispatched	After the current handler returns a task in the <b>In Elimination</b> state to the creator, the task enters the <b>To be dispatched</b> state. The creator can re-assign or cancel a task.
In Elimination	Submit the defect handling description and handling result. Alternatively, you can return the task to the upper-level handler for re-assigning the task.

Task Status	Description
To be approved	Accept the completed defect elimination task to ensure that the defects are completely eliminated.

## Managing Defect Elimination Tasks

1. On the **Elimination tasks** screen, tap . The **Task Management** screen is displayed.
2. Tap **Troubleshooting Management**, and tap and view all defect elimination tasks as required.

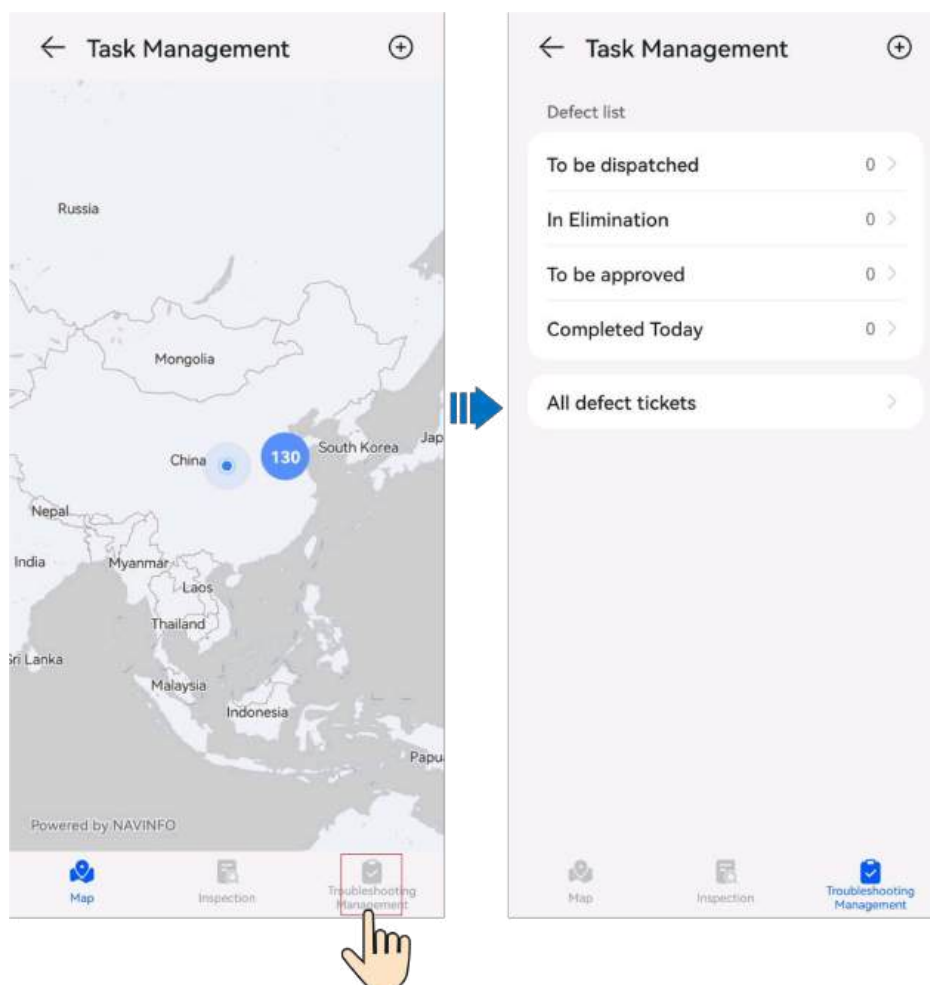

### 6.3.2.2 Inspection Management

Perform routine inspection on plant equipment to detect and report exceptions in a timely manner.

You can use the common inspection items preset by the management system for routine O&M of PV plants.

## Creating an Inspection Task

1. On the home screen, choose **Maintenance** > **Tasks**.
2. Tap . The **Task Management** screen is displayed.
3. Tap + in the upper right corner and select **Inspection**.
4. Fill in the ticket information as prompted and submit it.

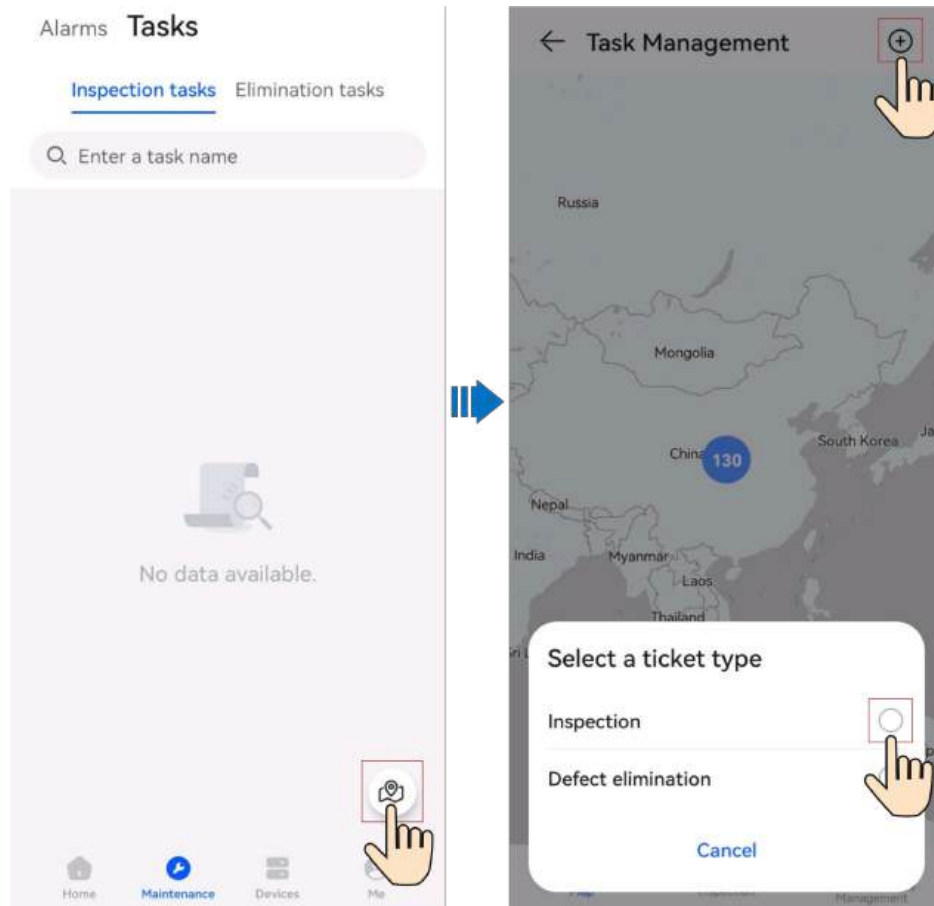

## Processing an Inspection Task

1. On the home screen, choose **Maintenance** > **Tasks** > **Inspection tasks**.
2. On the **Inspection tasks** screen, view and process inspection tasks.

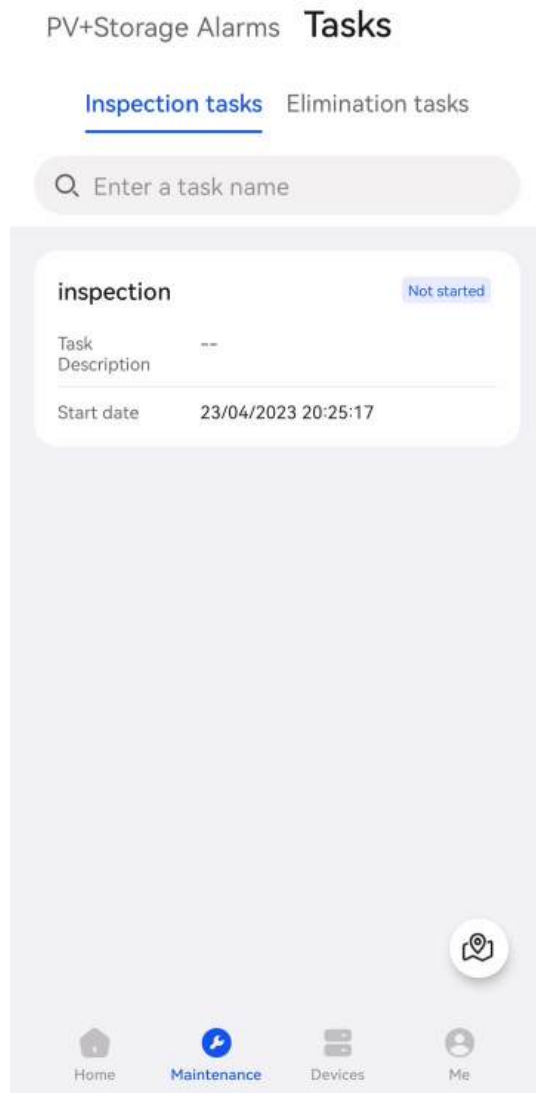

**Table 6-6** Inspection task status description

Task Status	Description
Not started	After receiving a task, the inspection personnel can tap the task to be inspected to start it. 1. Tap a task in the <b>Not started</b> state. The <b>Task Details</b> screen is displayed. 2. Tap <b>Start Inspection</b> to start the inspection task.
Inspection in progress	The inspection personnel can tap an inspection task to complete the inspection, fill in the inspection report as prompted, and save the report.
To be confirmed	You can accept the inspection tasks that have been completed.

Task Status	Description
Terminated	The current inspection task is complete.

## Managing Inspection Tasks

Inspection tasks can be viewed and managed by plant and task.

- By plant: View the historical inspection results and inspection details of a plant.
- By task: View the execution information about inspection tasks and process the tasks.

1. On the **Inspection tasks** screen, tap . The **Task Management** screen is displayed.
2. Tap **Inspection**. Tap **Plant list** or **Task list** as required to view all inspection tasks.
3. View and manage inspection tasks as prompted.

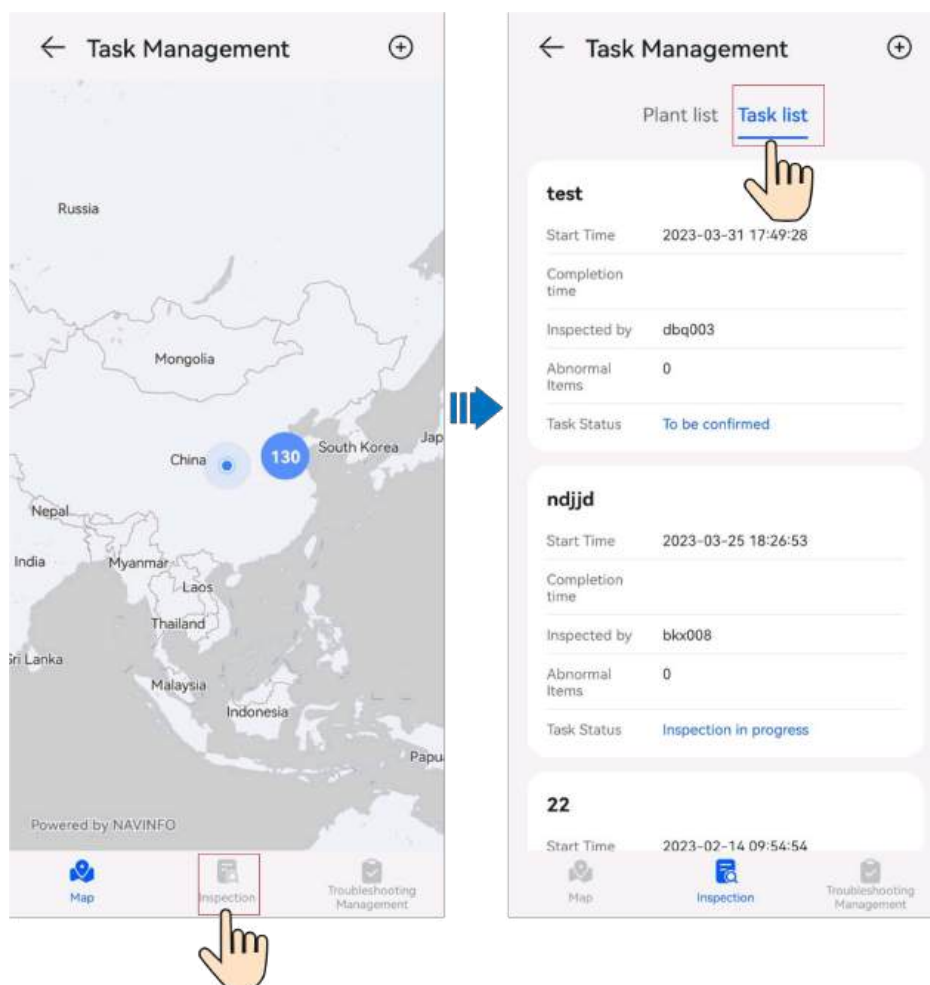

## 6.4 Device Management

You can monitor the device running status in real time, set parameters, replace devices, and change device names.

### Setting Device Parameters

1. Log in to the app and tap **Devices** on the home screen.
2. On the **Devices** screen, tap a device name.
3. Tap **::** in the upper right corner and tap **Parameter settings**.
4. On the **Parameter settings** screen, set parameters as required.
5. Tap **Confirm**.

#### NOTE

- The parameters that can be set vary with the device model. For details about parameter settings, see the user manual of the device.  
To obtain the manuals: Visit <https://support.huawei.com/enterprise/en/category/fusion-solar-pv-pid-1600073963553> and enter the desired device model to search for the corresponding user manual.
- For details about how to set energy storage parameters, see [11.4 Battery Parameters](#).

### Changing a Device Name

1. Log in to the app and tap **Devices** on the home screen.
2. On the **Devices** screen, tap a device name.
3. Tap **...** in the upper right corner and tap **Modify device name**.
4. Enter a new device name and tap **Confirm**.

### Replacing a Device

---

#### NOTICE



Ensure that the following conditions are met for device replacement:

- The current device is disconnected from the management system.
- The target device has been replaced and commissioned. For details, see *FusionSolar Smart PV Solution-Device Replacement Commissioning Guide* at <https://support.huawei.com/enterprise/en/doc/EDOC1100197498>.

- 
1. Log in to the app and tap **Devices** on the home screen.
  2. On the **Devices** screen, tap a device name.
  3. Tap **...** in the upper right corner and tap **Replace device**.
  4. On the **Replace device** screen, tap  to scan the QR code of the target device or enter its SN.

5. Tap **Replace**.

## O&M Authorization

1. Log in to the app and tap **Devices** on the home screen.
2. On the **Devices** screen, tap a device name.
3. Tap ... in the upper right corner and tap **O&M Authorization**.
  - When the button status is  , the WLAN is disabled.
  - To enable the WLAN, set the WLAN button to .

## Setting Third-Party Management System Parameters

1. Log in to the app and tap **Devices** on the home screen.
2. On the **Devices** screen, select the target Smart Dongle.
3. Tap ... in the upper right corner and tap **Parameter settings**.
4. In the management system-1 parameters, set **Connect** to **Enable**.
5. Set server parameters for the third-party management system as prompted.

## 6.5 Permission Management

View and manage the system permissions and status required by the FusionSolar app.

---

### NOTICE

To protect your information security, disable the permissions after using them.

---

### Procedure

1. Tap **Me > Settings > Permission Management** on the home screen.
  - On the **Permission Management** screen, you can view and manage the system permissions and status required by the FusionSolar app.
  - Enable or disable authorization: Touch the target permission and configure it as prompted.

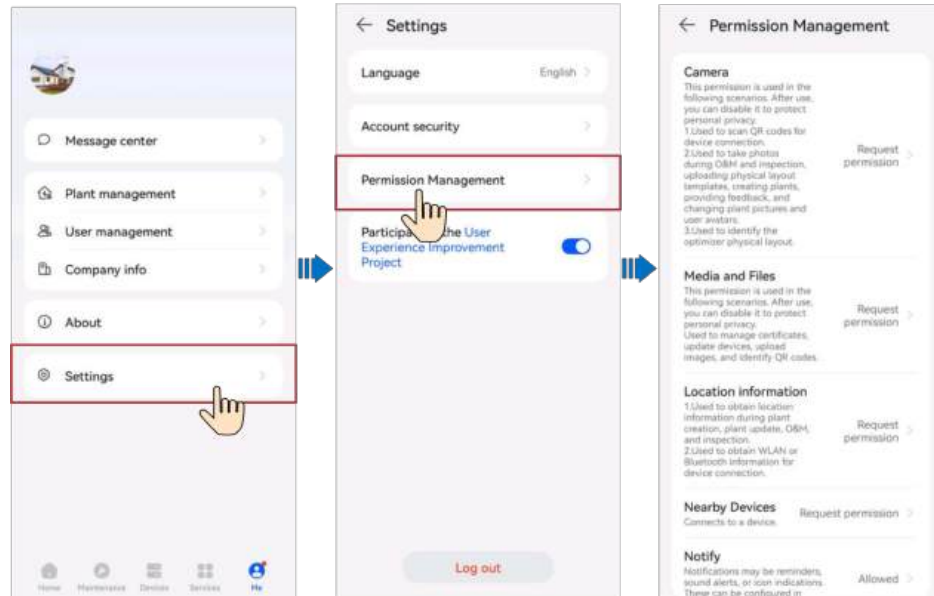

NOTE

- System permissions may vary based on Android or iOS.
- System permissions may vary based on roles.
- For details about required permissions, see **Me > About > Privacy Policy**.

## 6.6 Log Export

On the home screen, tap **Me > About**.

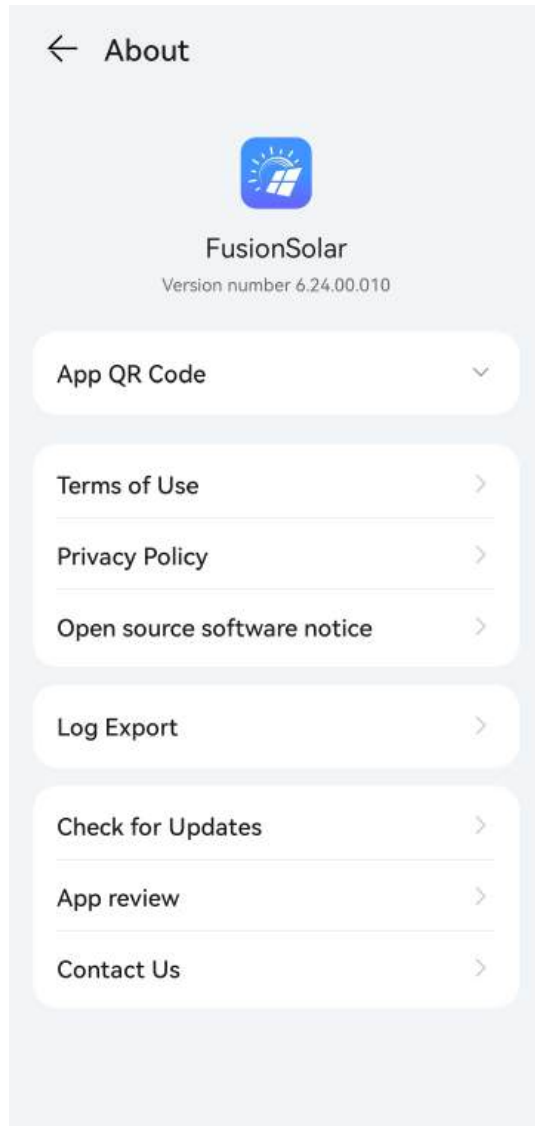

Tap **Log Export** to send logs to technical support engineers through Bluetooth, email, or other methods.

## 6.7 Services

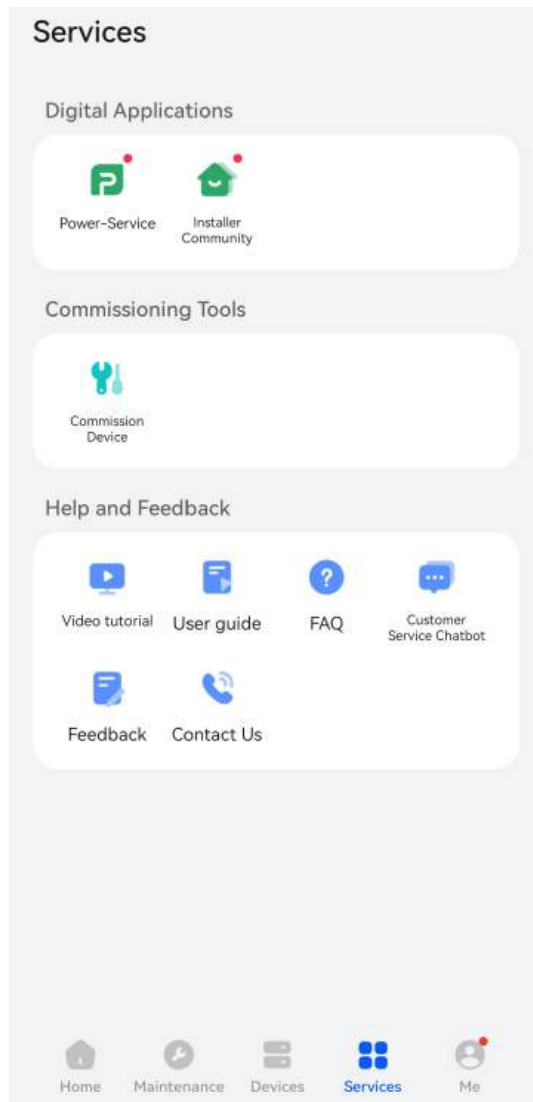

### Digital Applications

Users can quickly access the Power-Service and **Installer Community**.

#### NOTE

The mobile phone operating system earlier than iOS 13.0 does not support the Power-Service. To use the Power-Service, upgrade the system version or install the Power-Partner app.

### Commissioning Tools

**Device Commissioning:** navigates to the device commissioning screen to perform operations such as deployment and commissioning, and local O&M.

## Help and Feedback

Common functions include the user guide, FAQs, intelligent customer service, and feedback, which help you quickly understand device functions and solve problems.

1. **Video tutorial:** provides video tutorials for device deployment and commissioning, site deployment, user registration, and O&M.
2. **User Guide:** provides quick operation guide on functions as required.
3. **FAQs:** provides solutions to frequently asked questions.
4. **Feedback:** provides a feedback channel for users to help us improve user experience.
5. **Customer Service Chatbot:** helps users quickly solve problems through the one-to-one online customer service.
6. **Contact Us:** provides our contact information for users in case they have any questions about Huawei FusionSolar products.

# 7 I'm an Owner

---

You can use the FusionSolar app to check the power generation and consumption information of your home energy system anytime and anywhere.

## Home

After you update the software to 6.23.00.157 or later, if your associated plants do not exceed 10 and all plant types are **Residential**, you can tap **Me > Check for Updates** to switch to the new home screen.

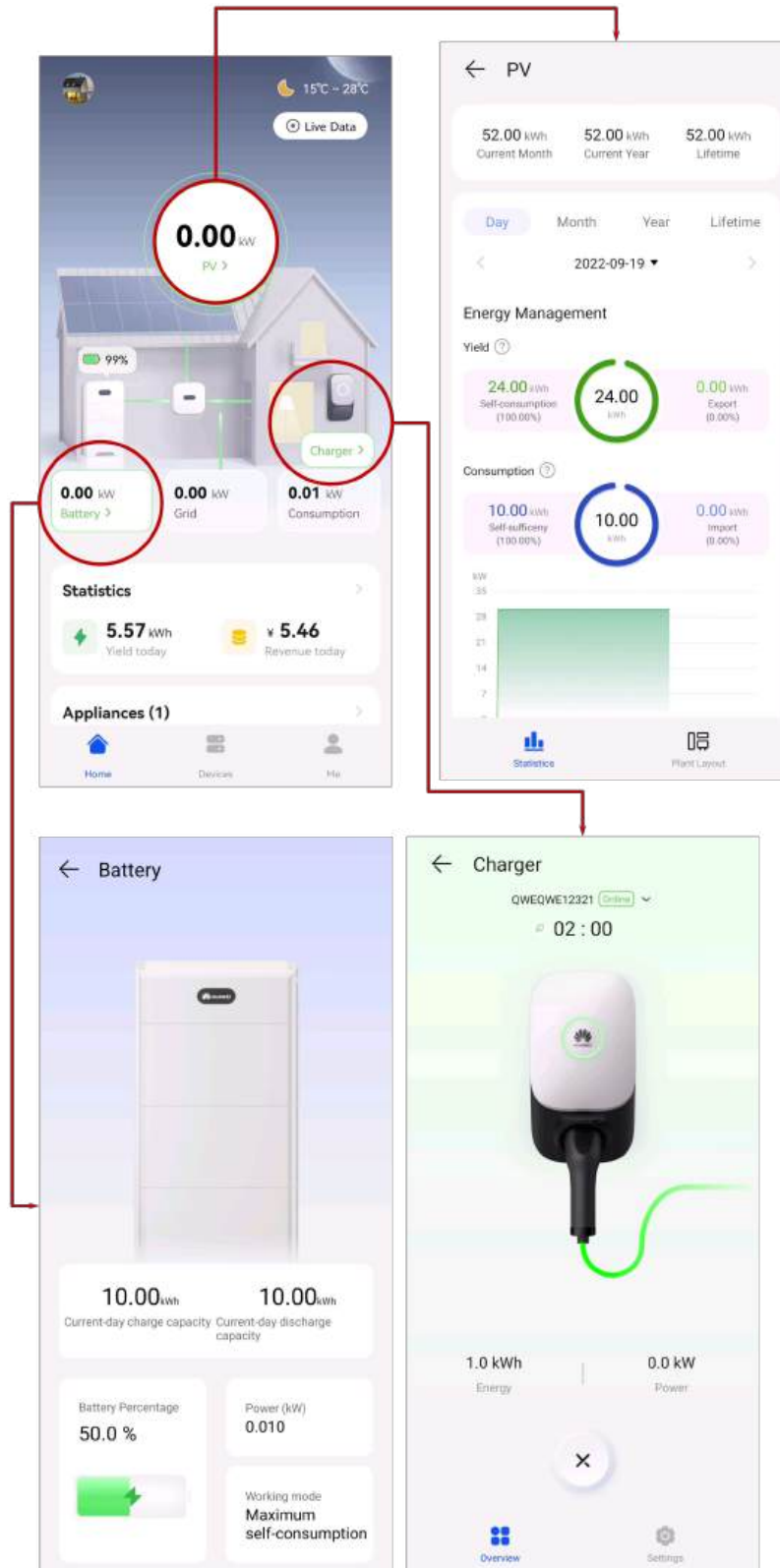

**NOTE**

For users with a charger only, the home screen is not displayed. In this case, the charger screen is displayed. For details, see [7.3 Using a Charger](#).

On the **Home** screen, tap **PV**, **Battery**, or **Charger** to view the running status and information of the corresponding device.

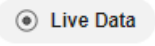
- If a plant has active alarms, the latest alarm information is displayed in the upper part of the **Home** screen. Tap the alarm to view its details.
- You can click  to view the energy flow map data in real time. To change the enabling duration, contact Huawei technical support. By default, this function is enabled for 1 minute. When this function is enabled, the traffic consumption increases. The number of sharing times on the web and app sides can be enabled for a maximum of 10 times per day.

 **NOTE**

- For details about PV devices, see [7.1 Viewing the PV Plant Status](#).
- For details about energy storage devices, see [7.2 Viewing the Battery Running Status](#).
- For details about chargers, see [7.3 Using a Charger](#).  
For details about environmental benefits, see [11.1 PV Power Generation Offsetting Carbon Emissions](#).

On the **Devices** screen, monitor the running status of devices in real time, change device names, and set parameters.

 **NOTE**

Only some devices support parameter settings. The parameter settings displayed on the screen may vary.

On the **Me** screen, set personal information and view more helpful information.

## 7.1 Viewing the PV Plant Status

Log in to the app and tap **PV** on the **Home** screen to view the PV yield statistics and plant layout.

### Statistics

You can view the energy yield and consumption, revenue, energy flow diagram, and environmental benefits in real time.

**Figure 7-1 Statistics**

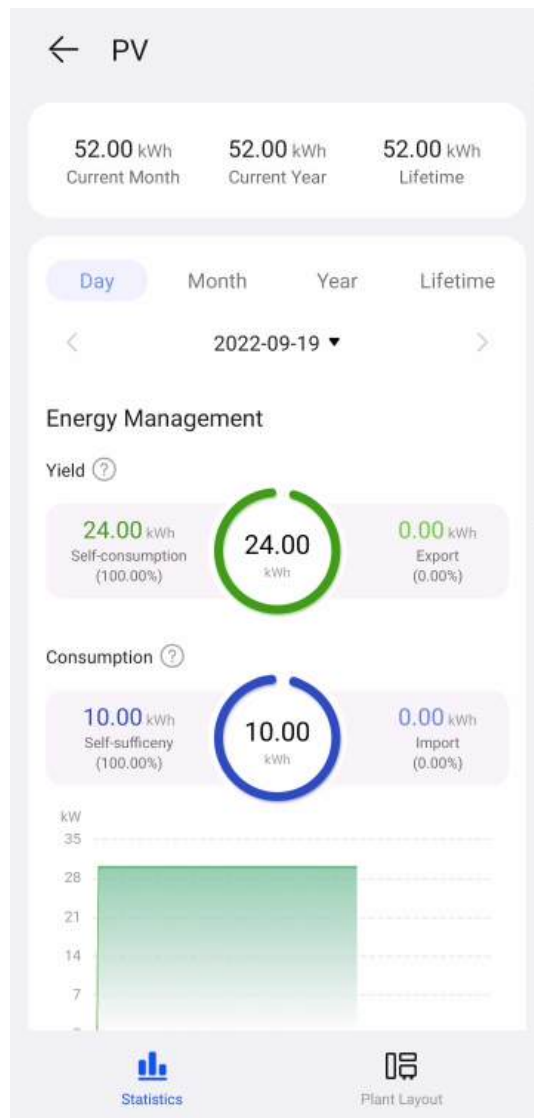

- Yield statistics: Displays the energy yield statistics of a plant.
- Energy management: Displays the energy yield, energy consumption, and self-consumption of a plant in different time dimensions, helping you analyze and optimize energy consumption. When an ESS is available, it stores and discharges energy, improving the self-consumption rate.
- Revenue statistics: Calculates the sum of feed-in revenue of a PV plant (feed-in electricity x feed-in tariff) and savings in electricity bills (self-consumed electricity x purchase price) to display the benefits brought by the PV plant.

## Viewing the Plant Layout (with Optimizers)

Tap **Layout**. The logical layout and physical layout are displayed. You can view the physical location and status of an optimizer.

- Tap a PV module to view the SN and running information.

- Tap  to display the logical connections between inverters and PV modules in different colors. PV modules connected to the same inverter are in the same color.

## 7.2 Viewing the Battery Running Status

Log in to the app and tap **Battery** on the **Home** screen to view the battery SOC, working mode, and charge and discharge energy of the current day in real time.



## 7.3 Using a Charger

## 7.3.1 Starting and Stopping Charging on the App

### Precautions

Before charging, you need to completely insert the charging connector into the charger and vehicle. If the indicator on the charger turns blue on and off cyclically (on for 4s and off for 1s), the charger is successfully connected to the vehicle.

### Starting Charging

On the charger screen, choose **Charge Now** > **Start Charging**. If the indicator on the charger turns blue on and off cyclically (on for 0.5s and off for 0.5s), the charger is in the charging state.



### Stopping Charging

After the vehicle is fully charged, the charger automatically stops charging. In this

case, the indicator is steady blue. You can also press and hold  on the app to stop charging.

## 7.3.2 Start Charging Through Authentication via Bluetooth

Complete the Bluetooth pairing of the charger on the app. Ensure that the app is running and that the Bluetooth function of the phone is enabled. When the phone

is close to the charger, the identity authentication is automatically completed and the charging starts.

## Precautions

Before charging, enable the [Authentication via Bluetooth](#) function.

## Starting Charging

1. Log in to the FusionSolar app (if you did not log out last time, simply open the app), and move your phone close to the charger to complete identity authentication.
2. Insert the charging connector completely into the charger and the charging port of a vehicle. If the indicator on the charger turns blue on and off cyclically (on for 0.5s and off for 0.5s), the charger is in the charging state.

## Stopping Charging

After the vehicle is fully charged, the charger automatically stops charging. In this

case, the indicator is steady blue. You can also touch and hold



on the app

or swipe the RFID card in the swiping area to stop charging.

## 7.3.3 Starting and Stopping Charging Using an RFID Card

### Precautions

- Before charging, ensure that you [add an RFID card](#) to the system.
- Before charging, you need to completely insert the charging connector into the charger and vehicle. If the indicator on the charger turns blue on and off cyclically (on for 4s and off for 1s), the charger is successfully connected to the vehicle.

### Starting Charging

Place the ring pattern on the [RFID](#) card in the swiping area. If the indicator blinks blue fast three times, the card is swiped successfully.

- If [Scheduled Charging](#) is not set, wait until the indicator on the charger turns blue on and off cyclically (on for 0.5s and off for 0.5s), indicating the charging state.
- If you have set the [Scheduled Charging](#), the charger enters the waiting state. The indicator is pulsating blue for 4s and off for 1s. When the scheduled time arrives, the charger automatically starts. You can also swipe the card again to charge immediately.

**Figure 7-2** Charging by card swiping

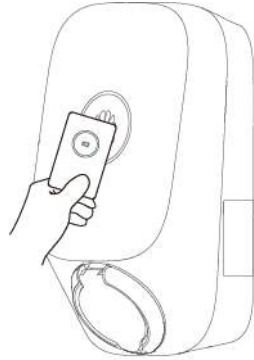

## Stopping Charging

After the vehicle is fully charged, the charger automatically stops charging. In this case, the indicator is steady blue. You can also swipe the RFID card in the swiping area to stop charging.

### 7.3.4 Plug-and-Play Charging

After the charging connector is inserted into the charging port of a vehicle, the charger automatically starts and stops charging.

## Precautions

To use plug-and-play charging, disable the **Identity Authentication** function. However, unauthorized charging may occur.

## Starting Charging

Insert the charging connector completely into the charger and the charging port of a vehicle. If the indicator on the charger turns blue on and off cyclically (on for 0.5s and off for 0.5s), the charger is in the charging state.

## Stopping Charging

After the vehicle is fully charged, the charger automatically stops charging. In this

case, the indicator is steady blue. You can also touch and hold



on the app

or swipe the RFID card in the swiping area to stop charging.

### 7.3.5 Scheduled Charging

You can use the scheduled charging function to charge your car during off-peak hours to save electricity fees.

## Precautions

Before charging, you need to completely insert the charging connector into the charger and vehicle. If the indicator on the charger turns blue on and off cyclically (on for 4s and off for 1s), the charger is successfully connected to the vehicle.

## Charging Procedure

1. On the charger screen, tap **Scheduled Charging**.
2. Tap **Schedule**. If the indicator on the charger turns blue on and off cyclically (on for 4s and off for 1s), the charger is in the scheduled charging waiting state.



## Setting the Scheduled Charging Time

1. On the charger screen, tap :: > **Settings** > **Scheduled Charging**.
  - Tap  to set the charging start time and end time.
  - Tap a scheduled charging plan to edit it.

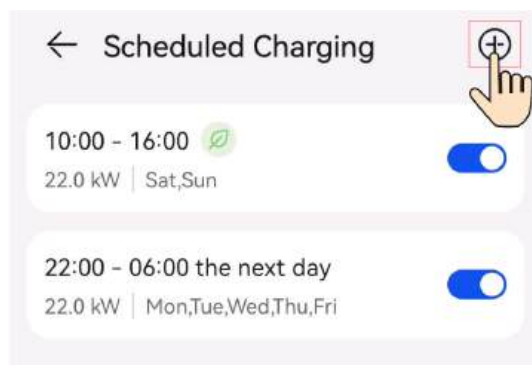

- Select a plan you want to delete, press and swipe left, and tap  to delete the scheduled plan.

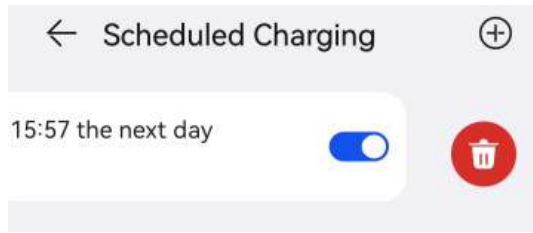

### 7.3.6 Charging for the Next Trip

Set the time of the next trip and required electricity. The EMMA flexibly adjusts the PV power and power drawn from grid based on the scheduled time and remaining PV power to meet requirements of your trip and maximize the PV power utilization.

Assume that you plan to set off for a beach campsite at 16:00 on Saturday and the trip will require 30 kWh electricity. You can submit the trip information on the app at 8:00 on Saturday and set the maximum charge power of your charger to 5 kW. The EMMA predicts that it will take about 6 hours to add a charge of 30 kWh. The charger enters the waiting state and automatically starts charging at 10:00.

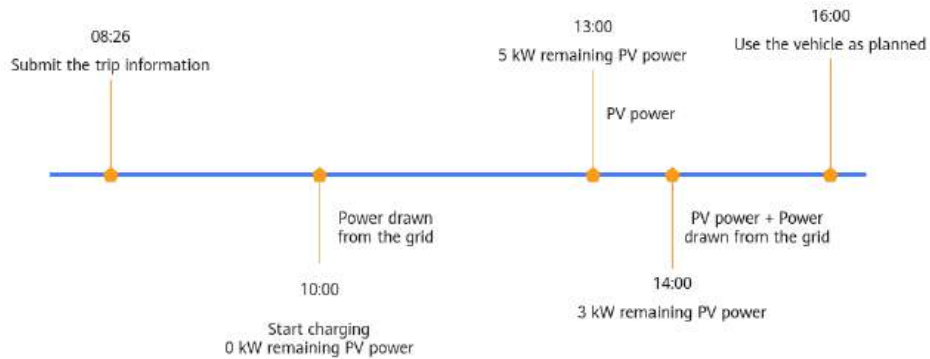

### Setting Trip Information

After connecting the charger to the vehicle, tap **Next Trip** on the charger screen and set the trip information as prompted.

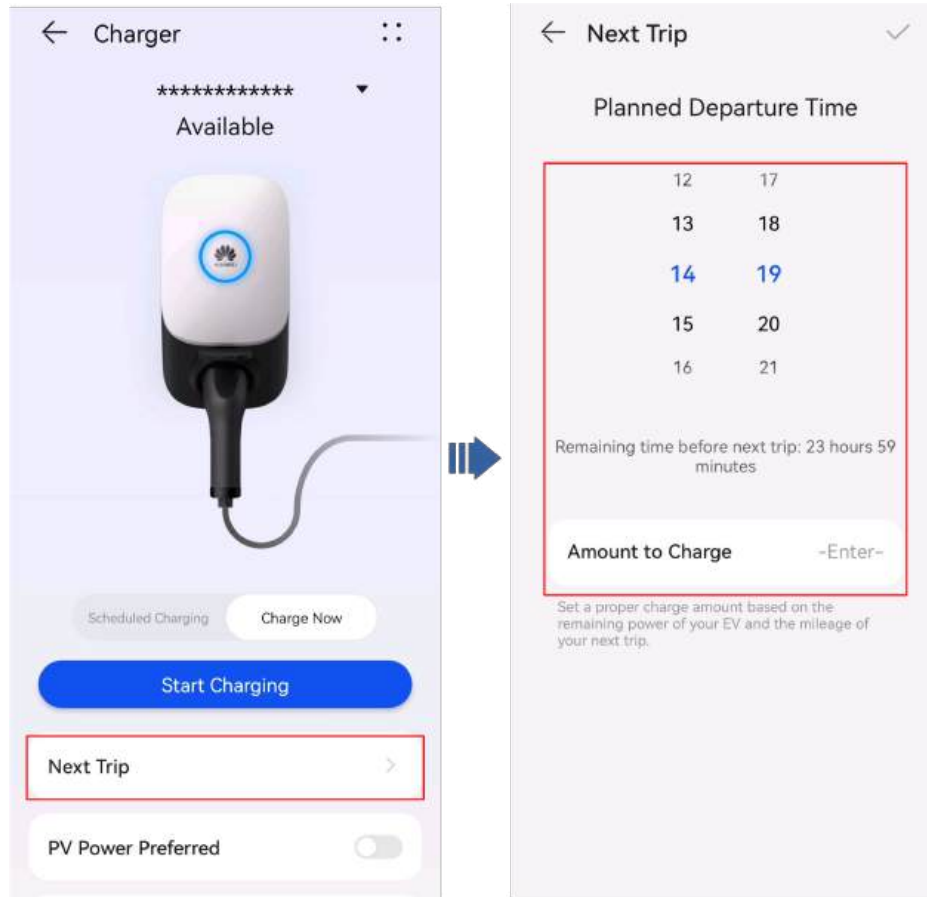

## Starting Charging

After the trip information is set, the EMMA automatically starts the system to charge the vehicle based on the scheduled time and required electricity.

## Stopping Charging

- When the battery level reaches the required electricity set for this trip, if you do not use the vehicle as planned and there is remaining PV power, the charger will continue charging using PV power until the vehicle is fully charged.

- Press and hold  on the app to stop charging.

## 7.3.7 Sharing the Charger

When the electric vehicles owned by other family members need to be charged, the owner can share the charger. The recipient can register a FusionSolar app account after receiving the shared email, and use the charger to charge the vehicles on the app.

## Adding a Recipient

1. On the charger screen, choose :: > **Settings** > **Shared devices**.
2. Tap **Share via email**, enter the email address of a recipient, and tap **OK**.

### NOTE

- You cannot share the charger with an email address that has been used to register a FusionSolar app account.
- After the sharing is successful, the system sends the shared email to the recipient.

## Sharing Management

You can view information about users and accounts that have been shared with your charger on the sharing management screen.

## Canceling Sharing

1. On the charger screen, choose :: > **Settings** > **Shared devices**.
2. Tap **Sharing Management**, select the user you want to cancel sharing, and then press and swipe left.
3. Tap  to cancel sharing.

### NOTE

After the sharing is canceled, the system automatically deregisters the sharing account.

## 7.3.8 Viewing Charging Records

On the charger screen, tap **Charging Record** to view the charging records of the past six months.

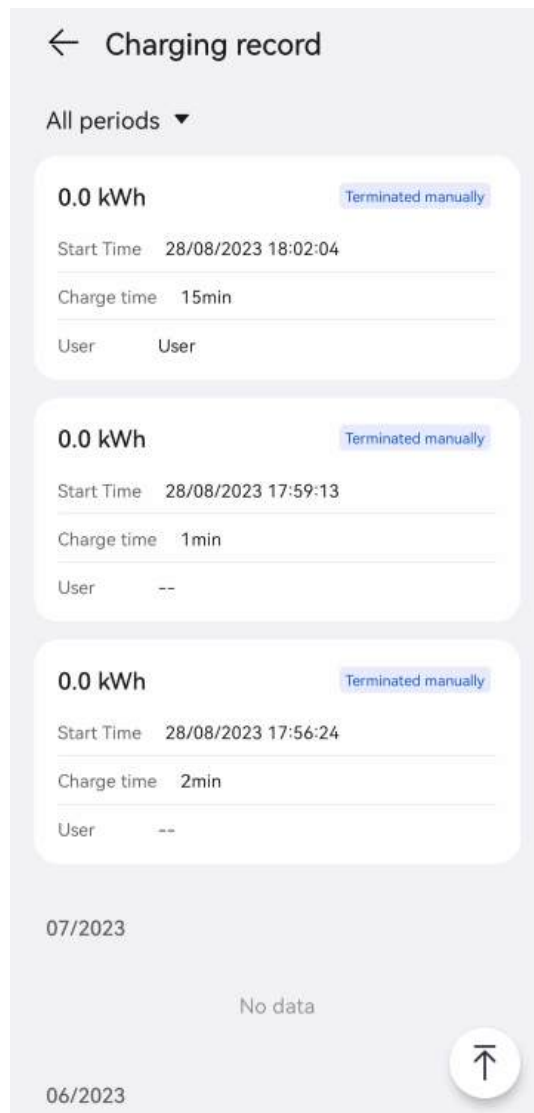

### 7.3.9 Load Priority

For a plant equipped with two chargers, if the sum of whose **Maximum Dynamic Power** is greater than the available power for all loads, you need to set the priority of the chargers to allocate the available power.

#### Preferentially Charging the ESS

After this function is enabled, the ESS is preferentially charged by the surplus PV power. If the surplus PV power is sufficient for more loads, the loads will be charged by priority.

#### Starting Loads by Priority

When the surplus PV power is greater than the surplus PV power threshold for power-on, the load at the highest priority is started first. Then, if the surplus PV power is sufficient for more loads, the loads are started by priority in descending order.

## Shutting Down Loads by Priority

When the surplus PV power or grid power is insufficient to support all loads, the loads are shut down by priority in ascending order.

### Procedure

1. On the charger screen, tap **:: > Settings > Load Priority**.
2. Touch and hold an appliance card and drag it to adjust the priority.

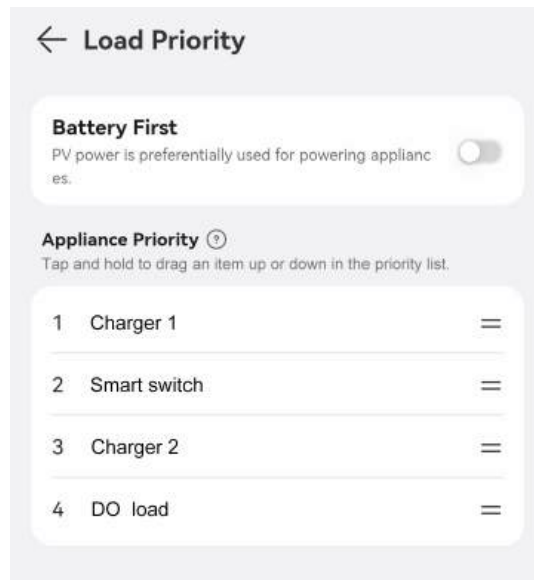

## 7.3.10 Settings

### Changing a Device Name

1. On the charger screen, choose **:: > Settings > Device name**.
2. Enter the charger name and tap **OK**.

### Maximum Dynamic Power (Maximum Charging Power)

Set the maximum charging power for the charger.

1. On the charger screen, choose **:: > Settings > Maximum Dynamic Power**.
2. Enter the charge power value.

#### NOTE

The actual screen may vary. For some charger versions, **Maximum Charging Power**, but not **Maximum Dynamic Power**, is displayed.

### Dynamic Charging Power

A meter must be configured for the dynamic charging power function. After this function is enabled, the system dynamically controls the charging power of the charger based on the home load power data collected by the meter. When detecting that the meter is disconnected, the charger switches to the minimum current mode to prevent the main circuit breaker from tripping.

1. On the charger screen, choose **:: > Settings**.
2. Enable **Dynamic Charging Power**.

 **NOTE**

**Dynamic Charging Power** is not displayed in EMMA scenarios.

## Configuring PV Power Parameters

After the **PV Power Preferred** mode is enabled, you need to set **Max Charging Power from Grid** and **Surplus Power to Start Charging** for the charger.

On the charger screen, choose **:: > Settings > Advanced Settings > PV Power Configuration**.

- **Max Charging Power from Grid:** This means the maximum power that the charger can draw from the power grid during charging in PV power mode.
- **Surplus Power to Start Charging:** In PV power mode, when the PV feed-in power is greater than this set value, the charger starts to charge the vehicle.
- **Switch Between Single- and Three-Phase Power:** You are advised to enable this function in PV scenarios to increase the PV energy utilization.

After this function is enabled, the system automatically switches to the PV power charging mode when detecting that the phase switching conditions are met. To ensure charging safety, the ongoing charging task will be interrupted for a short period of time. After the switching is complete, the charging task will be restarted.

The temporary interruption of charging caused by switching between single- and three-phase power will not cause damage to the vehicle.

 **NOTE**

- **PV Power Configuration** is displayed only in PV scenarios.
- **PV Power Configuration** is not displayed in EMMA scenarios.

## Maximum Mains Power

1. Choose **Devices > Appliances** and tap **:: > Settings**.

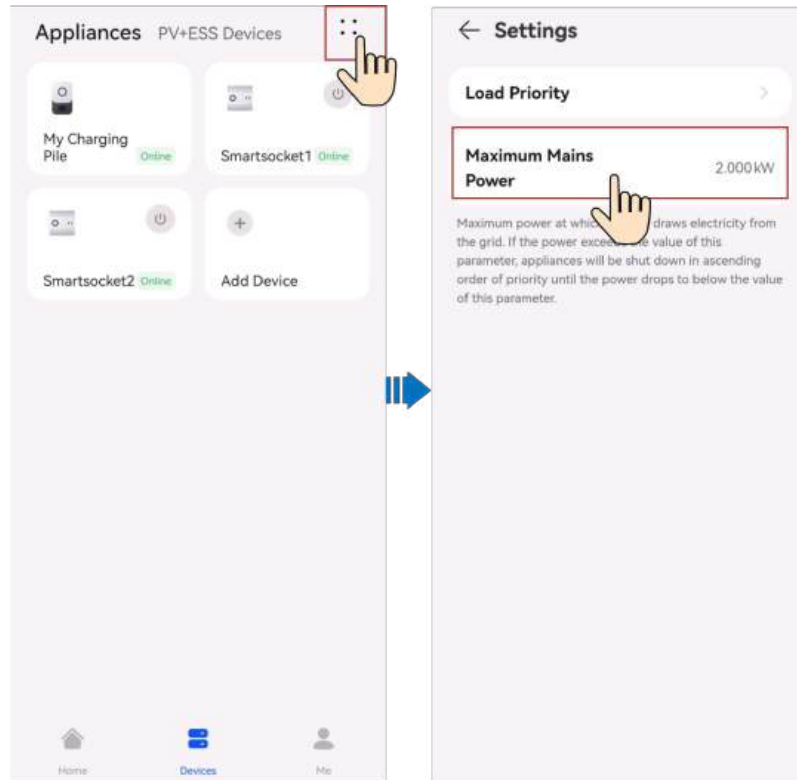

**NOTE**

**Maximum Total Purchase Power of Devices in PV Power Preferred Mode** needs to be set in EMMA scenarios.

## Authentication via Bluetooth

1. On the charger screen, choose **:: > Settings**.
2. Enable **Authentication via Bluetooth**.
3. If you use the function for the first time, follow the instructions to perform Bluetooth pairing.

## Identity Authentication

**NOTICE**

If identity authentication is disabled, the charger automatically starts charging after the charging connector is inserted into the charging port of a vehicle, which may result in unauthorized charging.

After identity authentication is enabled, you need to swipe a card for authentication before charging.

1. On the charger screen, choose **:: > Settings > Advanced Settings**.
2. Enable or disable **Identity Authentication**.

## Charging Connector Locking Mode

Set **Charging Connector Locking Mode** to lock the charging connector on the charger.

1. On the charger screen, choose :: > **Settings**.
2. Tap **Charging Connector Locking Mode** to set the charging connector locking mode.

## 7.4 Using a Shared Charger

### 7.4.1 Registering a Shared Account

After receiving an invitation email from the charger owner, follow the instructions in the email to register an account. After the registration is complete, you can log in to the FusionSolar app to use the charger.

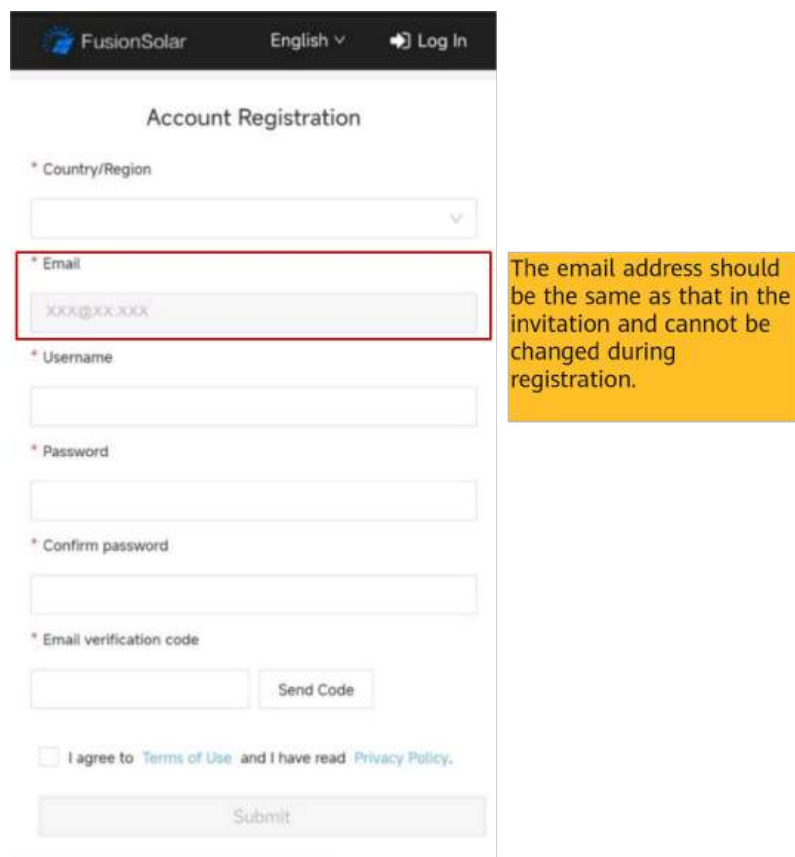

The screenshot shows the 'Account Registration' screen in the FusionSolar app. The form has the following fields and elements:

- Header: FusionSolar logo, English language selector, and Log In button.
- Title: Account Registration
- \* Country/Region: A dropdown menu.
- \* Email: A text input field containing 'xxx@xx.xxx', highlighted with a red border. A yellow callout box to the right states: 'The email address should be the same as that in the invitation and cannot be changed during registration.'
- \* Username: A text input field.
- \* Password: A text input field.
- \* Confirm password: A text input field.
- \* Email verification code: A text input field next to a 'Send Code' button.
- Agreement: A checkbox for 'I agree to [Terms of Use](#) and I have read [Privacy Policy](#).'
- Submit: A large button at the bottom.

### 7.4.2 Starting and Stopping Charging on the App

#### Precautions

Before charging, you need to completely insert the charging connector into the charger and vehicle. If the indicator on the charger turns blue on and off cyclically (on for 4s and off for 1s), the charger is successfully connected to the vehicle.

## Starting Charging

On the charger screen, choose **Charge Now > Start Charging**. If the indicator on the charger turns blue on and off cyclically (on for 0.5s and off for 0.5s), the charger is in the charging state.



## Stopping Charging

After the vehicle is fully charged, the charger automatically stops charging. In this

case, the indicator is steady blue. You can also press and hold



on the app to stop charging.

## 7.4.3 Setting the Charging Connector Locking Mode

### Charging Connector Locking Mode

Set **Charging Connector Locking Mode** to lock the charging connector on the charger.

1. On the charger screen, choose **:: > Settings**.
2. Tap **Charging Connector Locking Mode** to set the charging connector locking mode.

## 7.4.4 Logout

1. On the charger screen, tap **:: > Me**.
2. Tap **Settings > Log out** to confirm and log out.

## 7.5 Smart Appliance

### 7.5.1 Quick Guide to Smart Appliances

To meet the increasing electricity demand, homes are installing photovoltaic (PV) systems to generate green electricity with solar power. However, the traditional appliance management relies on manual control, with inefficient green power utilization and dumb power consumption scheduling.

The FusionSolar Smart Power Consumption Solution uses the EMMA as the brain of the home energy management system, together with the energy storage system (ESS), PV system, charger, and other home appliances to achieve smart management on home power consumption, improve the PV power self-consumption rate, and reduce power consumption costs. You can flexibly manage your home power consumption through functions such as load priority, power consumption schedule, and PV power settings on the app.

#### Setting the Load Priority by Importance

You can set the power consumption priority for different loads to specify which one is preferentially powered when the PV power is low.

#### Flexible Power Consumption Schedule for Load Startup/Shutdown

Loads can be flexibly started or shut down according to the peak-valley price difference and surplus PV power to slash electricity costs.

#### PV Power Preferred

You can set the parameters for the PV power preferred mode to supply surplus PV power to loads safely and cost-effectively.

#### User-defined Load Information for Real-Time Monitoring

You can flexibly modify the load name and customize the load icon to clearly view the load status.

### 7.5.2 Adding a Smart Appliance (Owner)

You can add a smart appliance to the FusionSolar app for management.

Smart appliances include smart switches (smart relays, sockets, and circuit breakers), heat pumps, and chargers.

- The EMMA controls the SG Ready heat pump directly or through an external relay.

- A smart relay, socket, or circuit breaker can connect to the same router as the EMMA over WiFi or FE.
- A charger can connect to the same router as the EMMA over WiFi or FE; or the FE port of the charger is directly connected to the LAN port of the EMMA. A charger can be automatically discovered during the deployment commissioning of the EMMA, no need to manually add it as a smart appliance.

## Appliance Settings

### NOTE

- The smart switches can work properly only when there are stable WLAN signals. If the signals are unstable, the switches may fail to connect to WLAN or frequently go offline. Different brands of smart switches may have different WLAN requirements. For details, see the product manuals or contact your supplier.
- Before the installation, ensure that the home router can cover the position of the smart switches with stable network connection, and perform the commissioning and verification.

1. Connect a smart switch to the same router as the EMMA. For details, see the quick guide delivered with the smart switch.
2. Open the FusionSolar app, choose **Devices** > **Appliances**, add the smart switch, and set the parameters such as the PV power parameters and power consumption priorities.

### NOTE

In the SmartGuard networking scenario, **Off-grid Load Control** does not take effect for smart appliances connected to non-backup power ports.

## Connecting to Multiple Smart Switches

To avoid confusion when multiple smart switches are powered on at the same time, power on and commission them one by one.

For example, if two smart circuit breakers (Shelly Pro 2PM) are installed in the living room, perform the following steps:

1. When installing the smart circuit breakers, record their positions by taking photos and notes, and number them.

**Table 7-1** Recording the names of the smart switches

Shelly Pro 2PM	Shelly Pro 2PM
Living room 1	Living room 2

2. Power on the smart circuit breaker "Living room 1," search for it in the Shelly app, and connect it to the router.
3. Log in to the FusionSolar app as an owner, search for it, and change its name. Bind it to the corresponding load based on the actual cable connection.

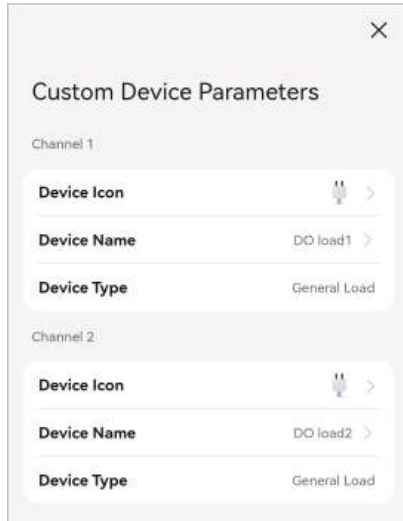

- Repeat steps 2 and 3 to power on and commission the smart circuit breaker "Living room 2."

**NOTE**

If multiple smart switches have been powered on without records in advance, you can power them on or off on the Shelly app to distinguish them.

### Adding Appliances on the FusionSolar App

- Log in to the FusionSolar app as the owner.
- Choose **Devices > Appliances**, and tap **Add Device**.
- Tap a discovered appliance and it will be automatically connected to the app.

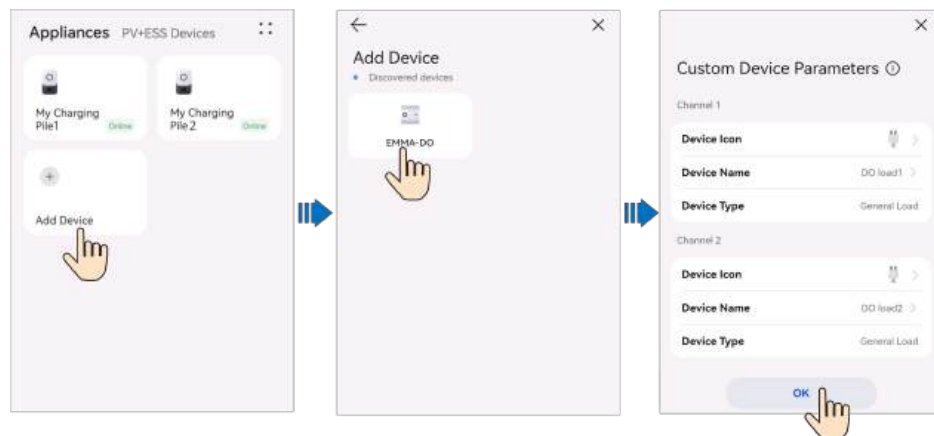

### 7.5.3 Quick Guide to PV Power Preferred

**NOTE**

If **Peak Power(kW)** set in **Peak Shaving** is less than **Maximum Mains Power**, the system will set the actual value of **Maximum Mains Power** to the value of **Peak Power(kW)** to meet the peak shaving requirement preferentially.

- Assume that your home has installed PV and ESS devices. In a season with sufficient sunlight, there is still surplus PV power in addition to power supplied to loads without smart switches. Then, you connect the smart

appliances including the charger, heat pump, and dishwasher (controlled by smart sockets) to the SmartPVMS to consume surplus PV power and save home energy expenses.

- Assume that the ESS works in **Maximum self-consumption** mode, and the surplus PV power is preferentially supplied to smart appliances. When PV power is insufficient, the ESS discharges for smart loads.

**Table 7-2** Parameters

Parameter	Description
Minimum charging power of the charger	Take a single-phase charger as an example. The minimum operating current is 6 A. When the voltage is 230 V, the charging power is about 1.38 kW.
<b>Maximum Dynamic Power</b> (Maximum charging power of the charger)	6 kW
<b>Maximum Mains Power</b> (Maximum power purchased by smart appliances from the power grid)	2 kW
<b>Surplus PV Power Threshold for Power-On*</b> for the heat pump	1 kW
<b>Surplus PV Power Threshold for Power-On*</b> for the dishwasher	1 kW
<b>Maximum discharge power</b> of the ESS	2 kW

 **NOTE**

- Note\*: In the **PV Power Preferred** scenario, when the surplus PV power is greater than **Surplus PV Power Threshold for Power-On**, loads will be powered on. If the rated load operating power is not met, the supplemental power will be purchased from the grid to power on the loads.
- Assume that the rated power of the dishwasher is 2 kW. If you want to use PV power as much as possible, set **Surplus PV Power Threshold for Power-On** to 2 kW. If you are willing to purchase some power from the grid, you can set **Surplus PV Power Threshold for Power-On** to 1 kW. When the surplus PV power reaches 1 kW, the dishwasher will be powered on with 1 kW supplemental power from the grid. After power-on, if the PV power is decreasing, you can purchase supplemental power from the grid to keep the dishwasher running until the **Maximum Mains Power** is reached.
- If you enable the mode that the ESS is preferentially charged, the surplus PV will be preferentially supplied to charge the ESS. If there is still sufficient power, the surplus PV power will be supplied to smart appliances.

Figure 7-3 PV Power Preferred (EMMA)

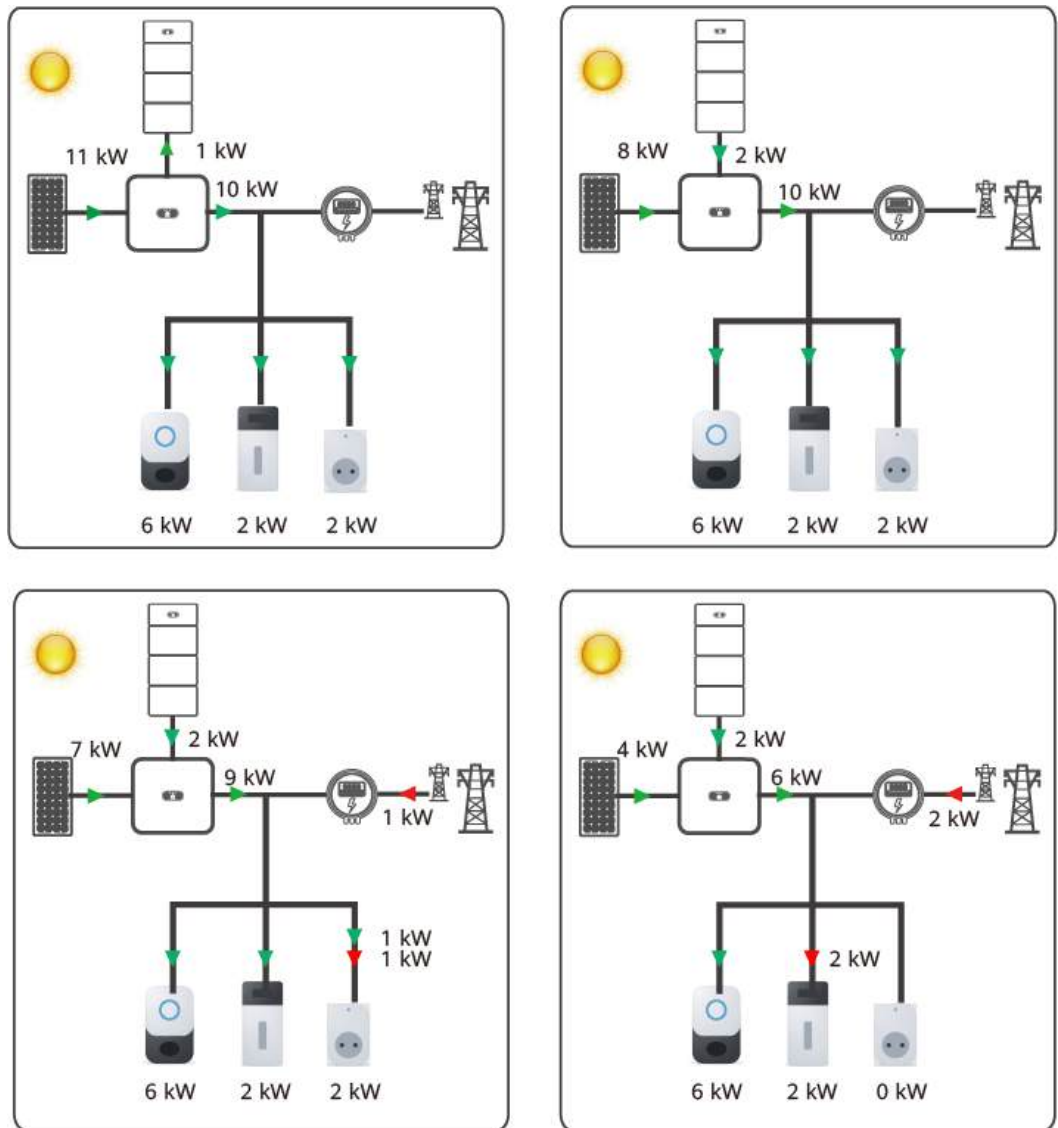

Scenario 1: The surplus PV power is 11 kW. The smart appliances consume 10 kW power, and the remaining 1 kW is used to charge the ESS.

Table 7-3 Scenario 1

Load Priority	Appliance	Surplus PV Power Threshold for Power-On	Operating Power	Status
1	Charger	1.38 kW (Retain the default value: minimum startup power)	1.38–6 kW	Running, <b>6 kW</b>
2	Heat pump	1 kW	2 kW	Running
3	Dishwasher	1 kW	2 kW	Running

Scenario 2: The smart appliances consume 10 kW power, with 8 kW from the surplus PV power, and 2 kW from the ESS discharge power.

**Table 7-4** Scenario 2

Load Priority	Appliance	Surplus PV Power Threshold for Power-On	Operating Power	Status
1	Charger	1.38 kW (Retain the default value: minimum startup power)	1.38–6 kW	Running, <b>6 kW</b>
2	Heat pump	1 kW	2 kW	Running
3	Dishwasher	1 kW	2 kW	Running

Scenario 3: The smart appliances consume 10 kW power, with 7 kW from the surplus PV power, 2 kW from the ESS discharge power, and 1 kW purchased from the grid.

**Table 7-5** Scenario 3

Load Priority	Appliance	Surplus PV Power Threshold for Power-On	Operating Power	Status
1	Charger	1.38 kW* (Retain the default value: minimum startup power)	1.38–6 kW	Running, <b>6 kW</b>
2	Heat pump	1 kW	2 kW	Running
3	Dishwasher	1 kW	2 kW	Running 1 kW power is purchased from the grid to meet the minimum operating power of the dishwasher.

Scenario 4: The smart appliances consume 8 kW power, with 4 kW from the surplus PV power, 2 kW from the ESS discharge power, and 2 kW purchased from the grid. According to the load priority, the dishwasher is shut down.

**Table 7-6** Scenario 4

Load Priority	Appliance	Surplus PV Power Threshold for Power-On	Operating Power	Status
1	Charger	1.38 kW (Retain the default value: minimum startup power)	1.38–6 kW	Running, <b>6 kW</b>
2	Heat pump	1 kW	2 kW	Running 2 kW power is purchased from the grid to meet the minimum operating power of the heat pump.
3	Dishwasher	1 kW	2 kW	Shut down

 **NOTE**

After smart appliances are shut down by priority, if you manually start an appliance, it will be supplied with power until you manually shut it down without being affected by the priority.

## 7.5.4 Enabling PV Power Preferred Mode

### Smart Appliance

You can enable **PV Power Preferred** for a smart appliance when setting the power consumption schedule.

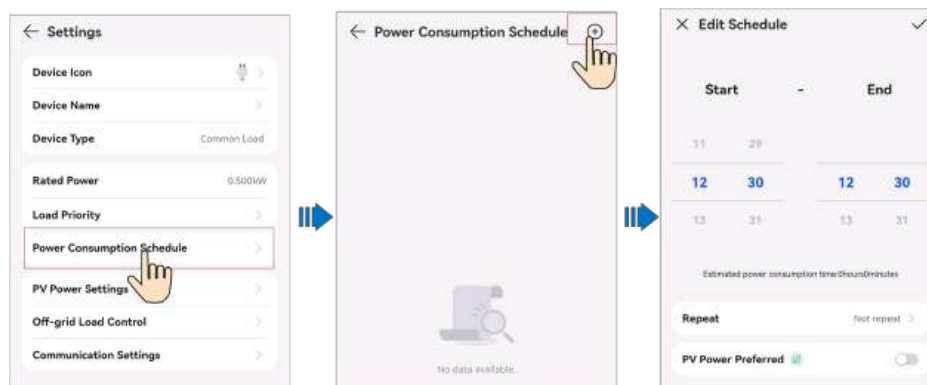

### Charger

In the **Charge Now** scenario, you can enable **PV Power Preferred** on the charger screen.

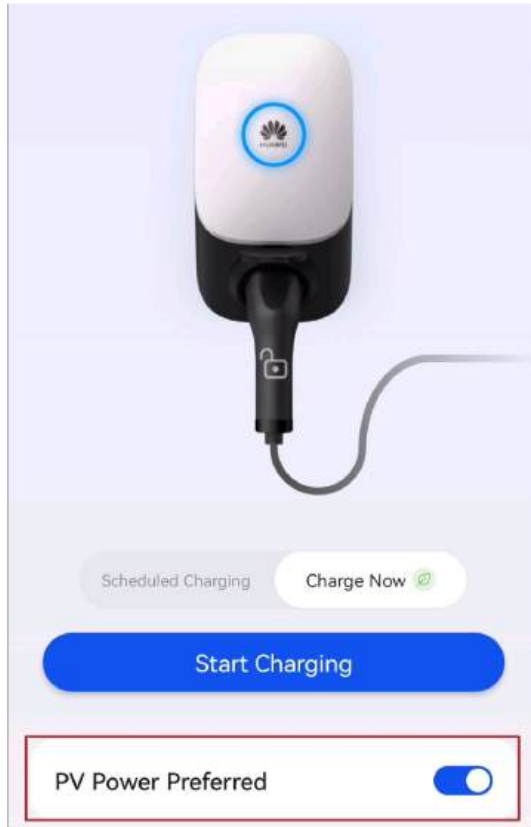

In the **Scheduled Charging** scenario, you can enable **PV Power Preferred** when setting the scheduled time.

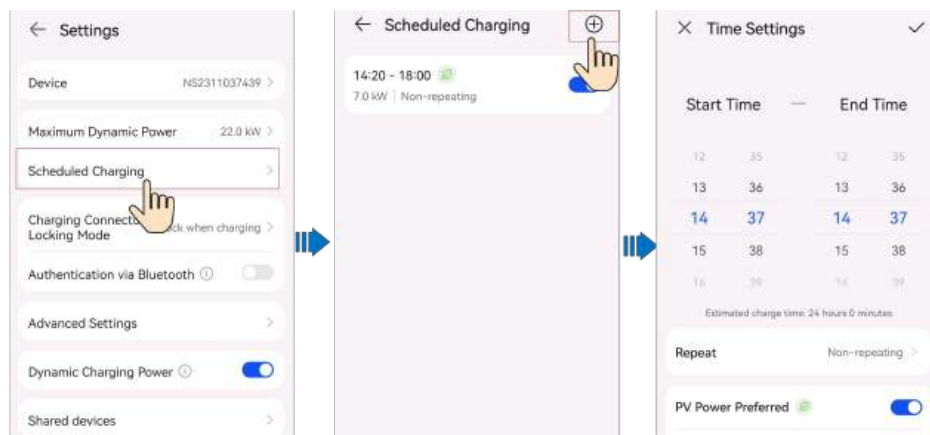

## 7.5.5 Power Consumption Schedule

You can schedule to start or shut down smart appliances at the specified time.

### Procedure

1. On the load details screen, tap **:: > Settings > Power Consumption Schedule**.
2. Tap **+** in the upper right corner to set the startup and shutdown time for the load.

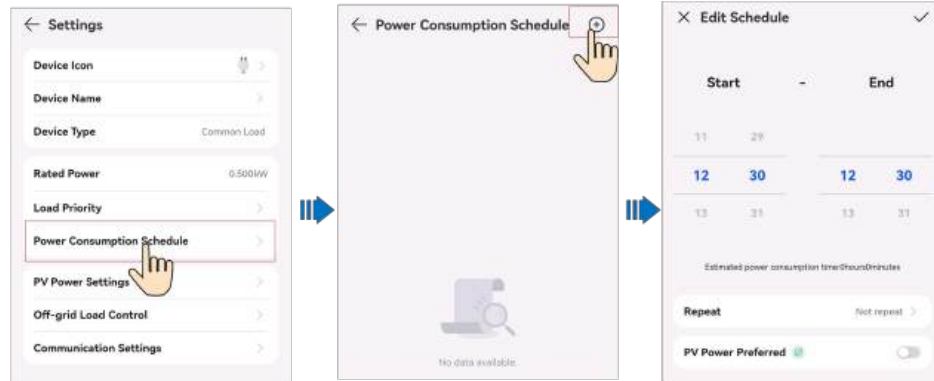

**NOTE**

If the **PV Power Preferred** mode is enabled but the PV power is less than the surplus PV power threshold for power-on when the scheduled time arrives, the load is not started temporarily.

## 7.5.6 Setting PV Power Parameters

### Surplus PV Power Threshold for Power-On

1. Choose **Devices > Appliances** and tap the target load.
2. Tap **:: > Settings > PV Power Settings**.

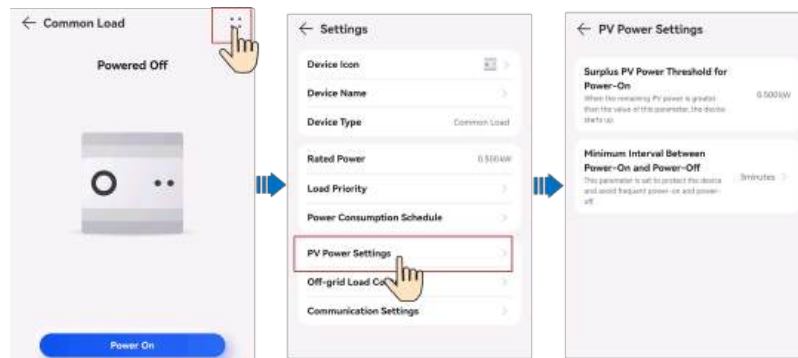

### Maximum Mains Power

1. Choose **Devices > Appliances** and tap **:: > Settings**.

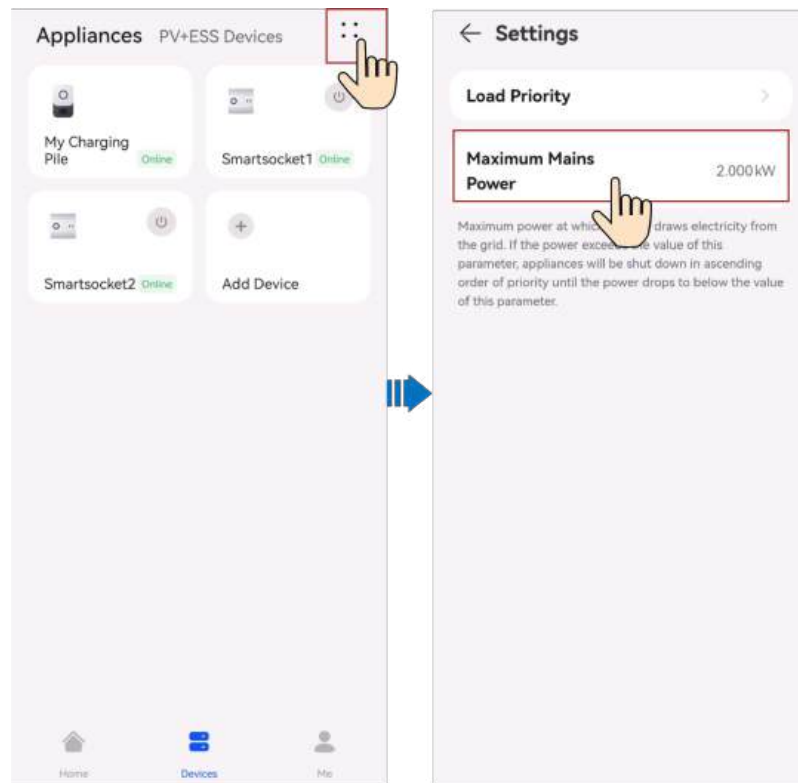

## 7.5.7 Setting the Load Priority

You can set the power consumption priority to specify the load that is preferentially powered when the PV power is low.

### Preferentially Charging the ESS

After this function is enabled, the ESS is preferentially charged by the surplus PV power. If the surplus PV power is sufficient for more loads, the loads will be charged by priority.

### Starting Loads by Priority

When the surplus PV power is greater than the surplus PV power threshold for power-on, the load at the highest priority is started first. Then, if the surplus PV power is sufficient for more loads, the loads are started by priority in descending order.

### Shutting Down Loads by Priority

When the surplus PV power or grid power is insufficient to support all loads, the loads are shut down by priority in ascending order.

### Procedure

1. Choose **Devices** > **Appliances** and tap the target load.
2. Tap **::** > **Settings** > **Load Priority**.
3. Touch and hold an appliance card and drag it to adjust the priority.

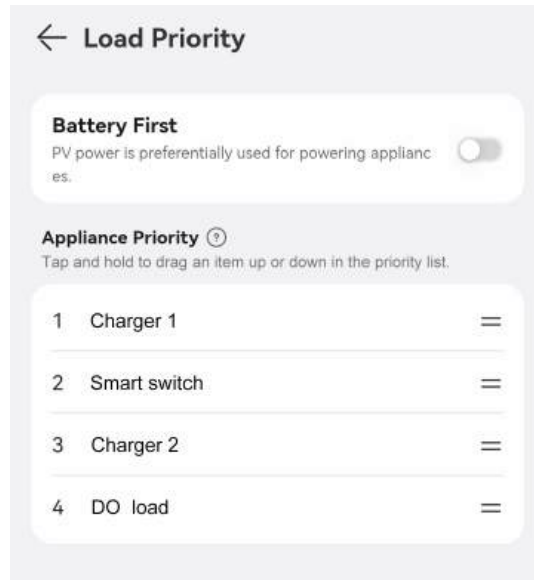

## 7.5.8 More Settings

### 7.5.8.1 Parameter Settings

#### User-defined Load Name

1. On the load management screen, tap a target load.
2. Tap **:: > Settings > Device name**.

#### Off-grid Load Control

In the whole-house power backup networking, you can set **Off-grid Load Control** to determine whether to continue supplying power to loads connected to the backup power ports in off-grid mode. After **Automatic Control** is enabled, you can set the power supply mode for loads in off-grid mode.

1. On the load management screen, tap a target load.
2. Tap **:: > Settings > Off-grid Load Control**.

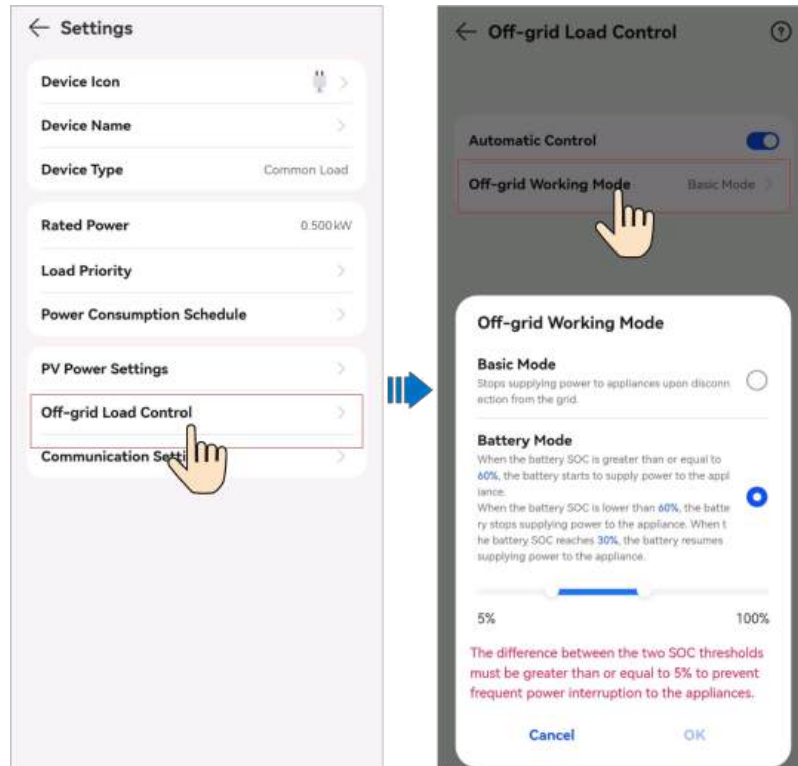

## Minimum Interval Between Power-On and Power-Off

After the surplus PV power threshold for power-on is set, if the PV power output is unstable, loads will be frequently powered on and off. To ensure safe operations of loads, you can set a minimum interval for loads to stay in the current status after the loads are powered on or off.

Tap :: > **Settings** > **PV Power Settings** on the load management screen.

### 7.5.8.2 Setting Communication Parameters for Smart Appliances

Communication parameters indicate the access mode of your smart appliances. When the access mode of an appliance changes (for example, a smart circuit breaker is replaced or adjusted), you can modify the communication parameters of the appliance without adding it to the app again.

Assume that you install a humidifier in the living room and control the startup or shutdown of the humidifier through a smart circuit breaker.

**Figure 7-4** Living room scenario

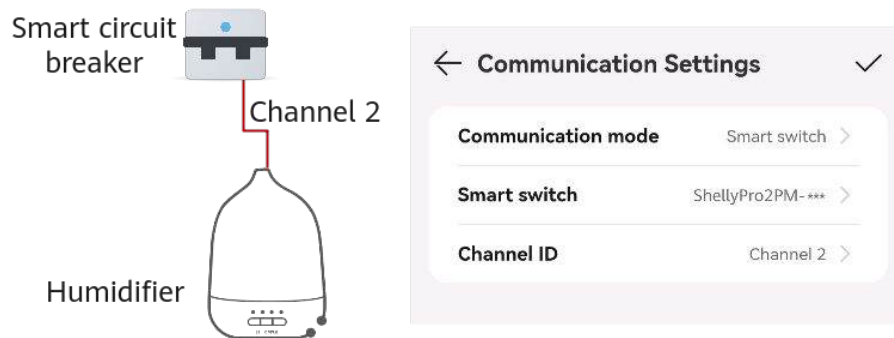

After using the humidifier for a period of time, you want to move the humidifier to the bedroom and use a smart socket to control the humidifier. You need to modify the communication parameters of the smart circuit breaker corresponding to the humidifier. Otherwise, you cannot start or shut down the humidifier through the app.

**Figure 7-5** Bedroom scenario

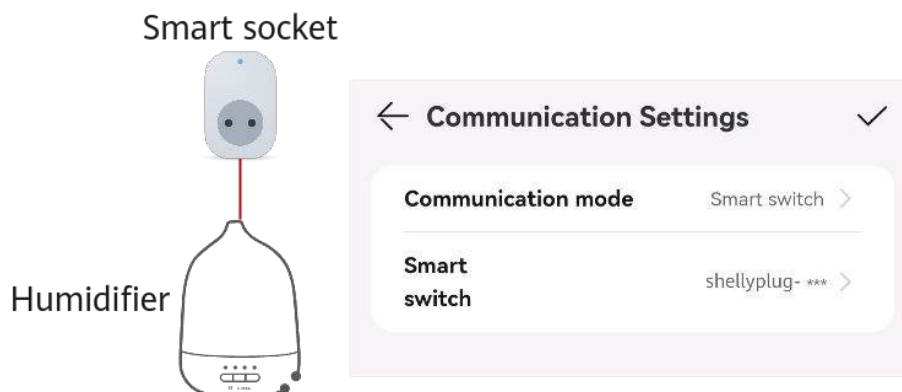

## Procedure

1. On the load management screen, tap a target load.
2. Tap **:: > Settings > Communication Settings**.

## 7.6 Load Shedding

Huawei FusionSolar Smart PV Management System (SmartPVMS) adapts to the dynamic load shedding plans for power grids in South Africa and enables users to formulate power backup plans on the FusionSolar app based on the power supply or load shedding duration, ensuring sufficient battery energy for loads during load shedding.

**NOTICE**

- Load shedding is supported only for scenarios where the EMMA is installed.
- Load shedding is supported only for plants in South Africa. Set the country/region and address of the plant correctly. Otherwise, no load shedding plan can be obtained.

**Procedure**

1. Choose **Devices > Appliances** and tap **:: > Settings**.
2. Tap **Load Shedding**.
3. After **Load Shedding** is enabled, tap **Region** and select the region where the plant is located to obtain the local load shedding plan.
4. Set the power backup plan as prompted. The EMMA will charge the batteries to the specified SOC value before the load shedding starts.

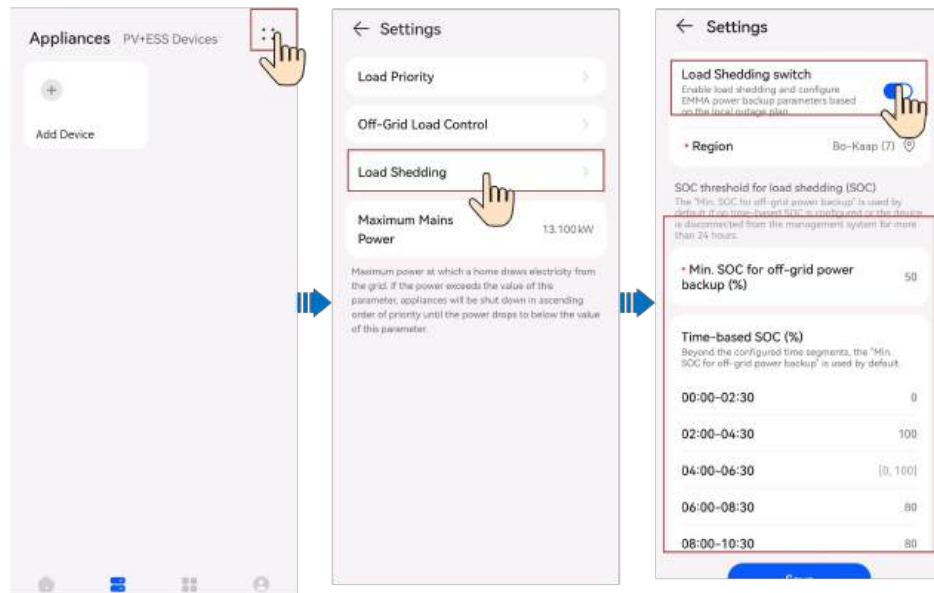

**7.7 Managing Devices**

You can view the real-time, historical, and basic information about a device.

**Viewing Real-Time Information**

On the **Real-time info** screen, you can view key running parameters such as the device running status and energy yield.

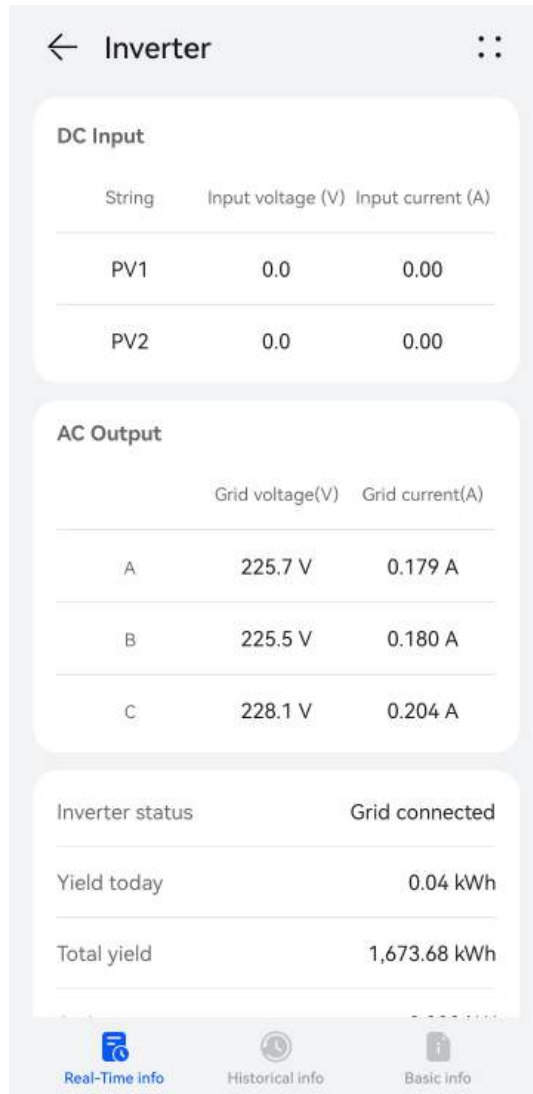

## Viewing Historical Information

On the **Historical info** screen, you can query the running status of devices in a specified period.

Set **Signal type**, **Signal point** and **Date**, and view the query results of historical information.

### NOTE

If the data in a certain period is incomplete or missing, contact the installer to collect the missing data.

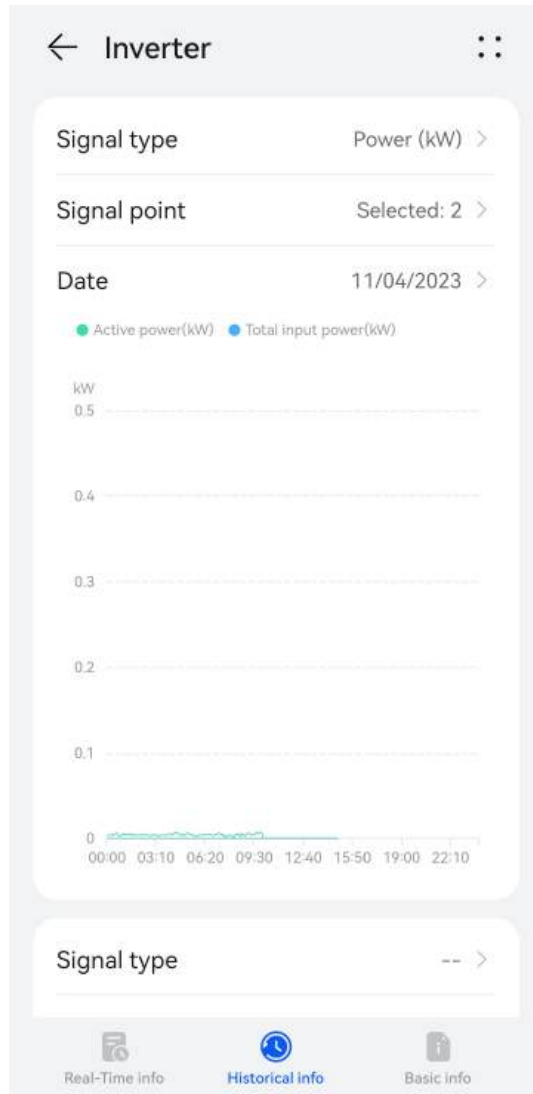

## Querying Basic Information

On the **Basic info** screen, you can view basic information such as the device type and SN.

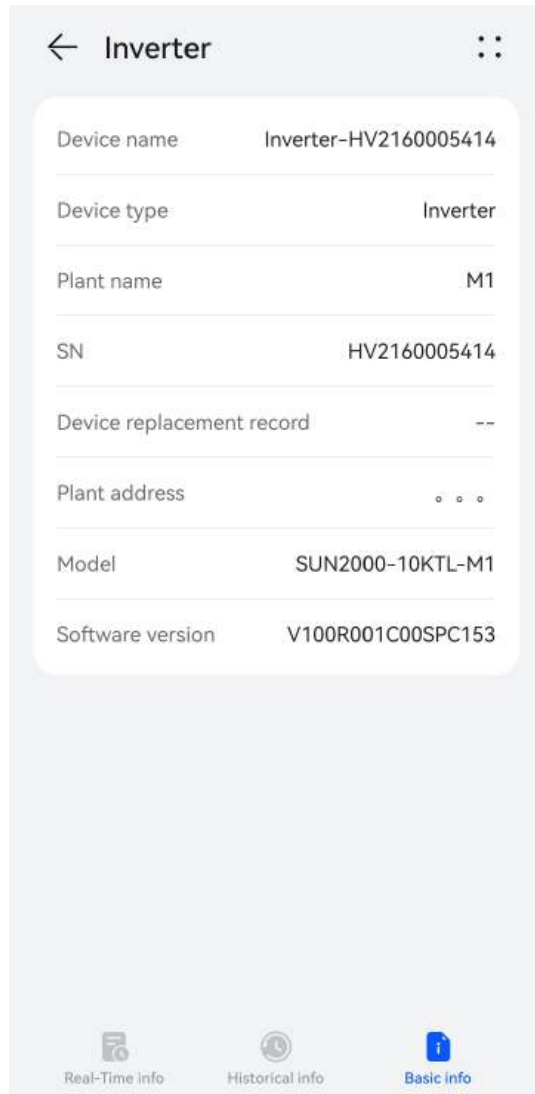

## Setting Device Parameters

1. On the **Devices** screen, tap a target device.
2. Tap **::** in the upper right corner and tap **Parameter settings**.
3. On the **Parameter settings** screen, set parameters as required.
4. Tap **Confirm**.

### NOTE

- The parameters that can be set vary with the device model. For details about parameter settings, see the user manual of the device.  
To obtain the manuals: Visit <https://support.huawei.com/enterprise/en/category/fusion-solar-pv-pid-1600073963553> and enter the desired device model to search for the corresponding user manual.
- For details about how to set energy storage parameters, see **11.4 Battery Parameters**.

## 7.8 Managing Plants

On the app, you can modify the basic plant information and electricity price information, and unbind or delete devices.

### Modifying Basic Plant Information

You can change the plant address, time zone, and other information.

1. Choose **Me > Plant management** and tap the target plant.
2. On the **Basic info** screen, tap  in the upper right corner.
3. Modify related information as required and tap **Save**.



### Modifying the Electricity Price

If the electricity price varies or changes in different time periods, you need to modify the electricity price to ensure that the plant benefit calculation is more accurate.



1. Choose **Me > Plant management** and tap the target plant.
2. Tap **Set Electricity Prices**.
3. Tap  in the upper right corner and set **Feed-in tariff** and **Purchase price** as prompted.
4. Tap **Save**.

 **NOTE**

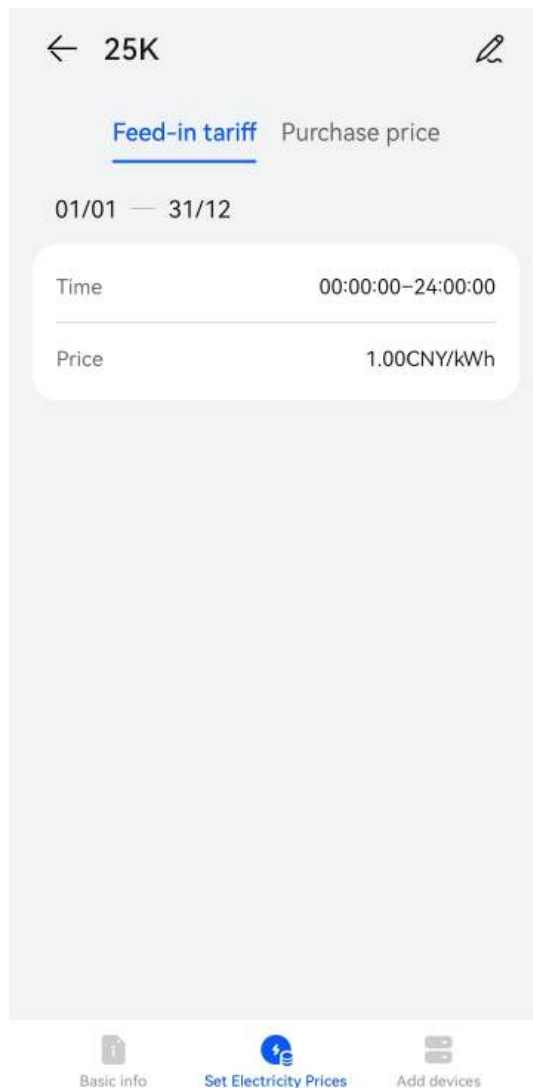
If the electricity price unit is inconsistent with the local currency, contact the installer to change the currency.



## Binding a Device

1. On the **Me > Plant management** screen, tap the target plant.
2. Tap **Add devices** and then .
3. Tap  to scan the QR code on the device. Then, tap **Save**.

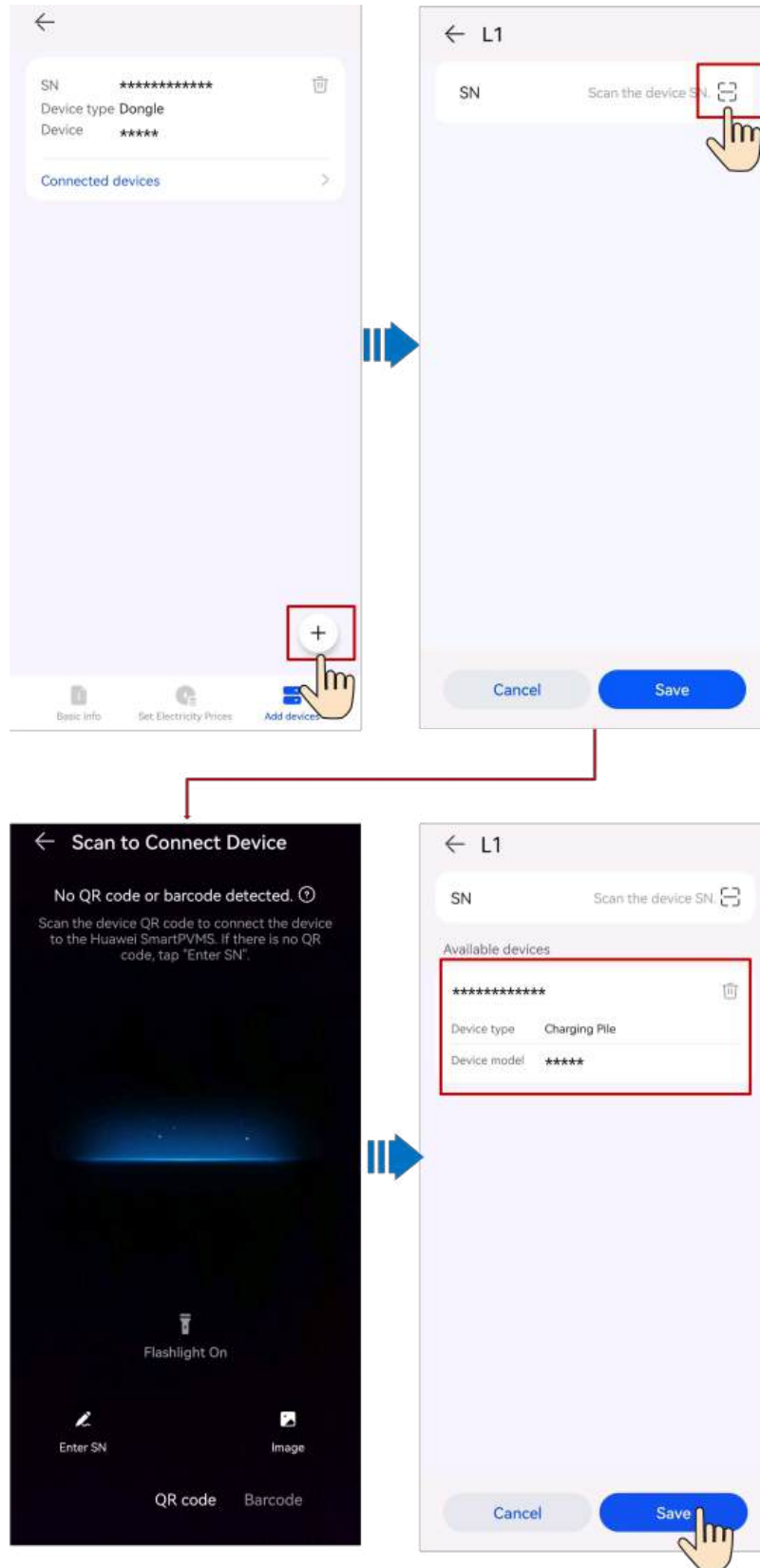

## Unbinding or Deleting Devices

1. Choose **Me > Plant management** and tap the target plant.

2. Tap **Add devices**.
3. Tap  and select **Unbind Device** or **Delete Device** based on the site requirements.

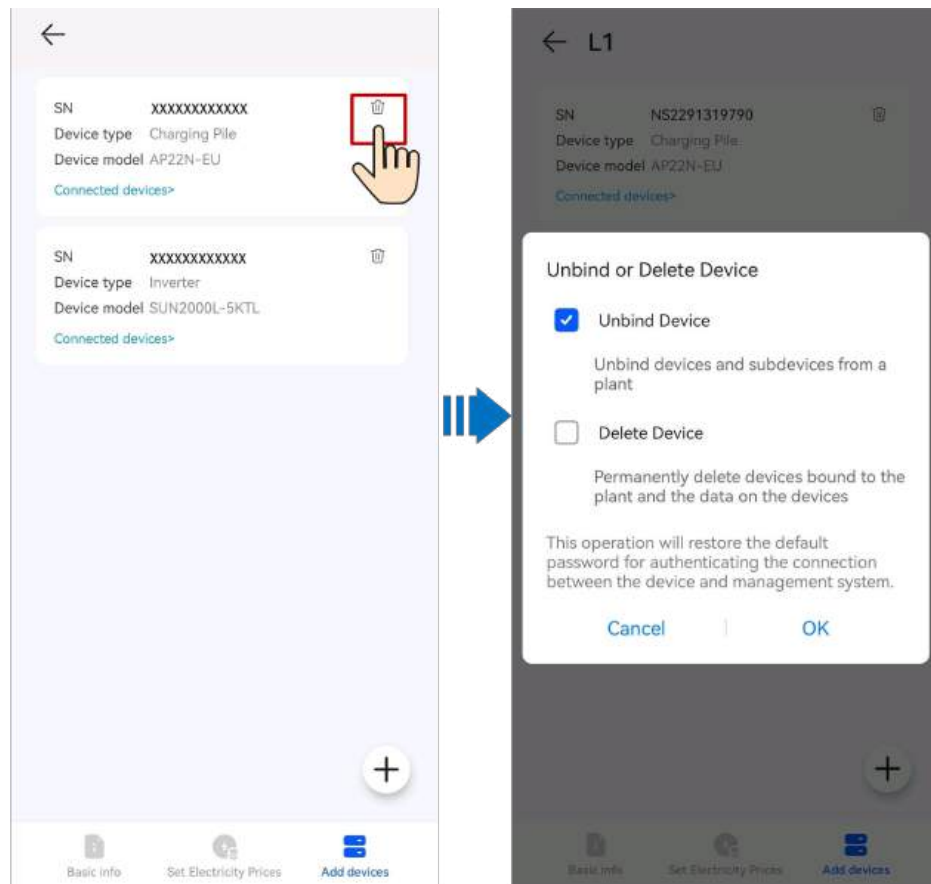

 **NOTE**

- After a device is unbound, the running data of the device and its subdevices is stored in the database. The default data retention period is six months. To change the retention period, contact the system administrator.
  - If a device is rebound to a plant within the data retention period, the device inherits the retained data.
  - If a device is not bound to a plant within the data retention period, the data will be automatically deleted.
- After a device is permanently deleted, the running data of the device and its subdevices is deleted immediately. When the device is bound to the plant again, the running data of the device is not restored.

## 7.9 Enabling EMMA

The AI Energy Management Assistant (EMMA) provides intelligent energy scheduling and management functions. Based on big data analysis, it accurately predicts the power generation and consumption curves of households, and intelligently stores, purchases, and sells electricity to achieve optimal system performance, improve the utilization rate of PV power, and maximize financial benefits.

## Procedure

After the owner logs in to the app, if the system determines that the plant meets the conditions for enabling the EMMA function, **Enable EMMA to improve revenue** is displayed below the energy flow diagram. Tap it to enable the EMMA function.



### NOTE

Only owners have the permission to enable the EMMA function. After the EMMA function is enabled, owners and installers can view the EMMA revenue and energy forecast.

## Viewing the Revenue After EMMA Was Enabled and Energy Forecast

1. Tap the EMMA card on the home screen of the app to view the revenue information, revenue comparison, and energy forecast.
  - Viewing the revenue comparison: In the **Revenue Comparison** area, view the comparison between the revenues when EMMA is enabled and disabled.

- Viewing energy forecast: In the **Energy Forecast** area, view details about the energy yield, power consumption, and battery charge and discharge in the past 24 hours, and energy forecast in the next 24 hours.

## Disabling EMMA

1. On the top right corner of the **EMMA** screen, choose :: > **More Settings** > **Disable** to disable the EMMA function as prompted.

### NOTE

- After the **EMMA** function is disabled, you can still view historical revenue information and revenue comparison.
- You cannot enable **EMMA** again in the same month after disabling it to ensure the accuracy of revenue calculation. In the next month, when the system determines that the plant meets the conditions for enabling **EMMA**, you can enable **EMMA** again as prompted.

## 7.10 Setting Electricity Prices (Simple Price)

Configure the time-of-use electricity prices to calculate the revenue based on different electricity prices in different time segments so that the calculation is more accurate.

1. On the home screen of the app, choose **Me** > **Plant management**. In the plant list, tap the target plant.
2. Tap **Set Electricity Prices**.
3. Tap  in the upper right corner and set **Purchase price** and **Feed-in tariff** as prompted.

## 7.11 Set Electricity Prices (Compound Price)

### 7.11.1 Purpose

FusionSolar Smart PV Management System (SmartPVMS) can calculate the PV plant benefit based on the electricity price information set by users. The PV plant benefit consists of the revenue of power fed to the grid (feed-in power x feed-in tariff) and savings on electricity bills (self-supplied power x purchase price).

- Feed-in tariff: indicates the unit price of PV power fed to the grid.
- Purchase price: indicates the unit price of electricity purchased from the grid when the PV power is insufficient.

### 7.11.2 Setting the Feed-in Tariff

1. Choose **Me** > **Plant management** on the home screen of the app and tap the target plant in the plant list.
2. Choose **Set Electricity Prices** > **Feed-in tariff**.
3. Set the time segment and enter the feed-in tariff in the time segment.

If the feed-in tariff varies based on time segments or date periods, you can tap **Add Time Segment** and **Add date period** to set multiple time segments and date periods.

## 7.11.3 Configuring a Purchase Price

### NOTICE

Before configuration, set the correct country/region where the plant is located and the correct plant type. Otherwise, the system cannot push the electricity price template of the target country/region.

1. Choose **Me > Plant management** on the home screen of the app and tap the target plant in the plant list.
2. Choose **Set Electricity Prices > Purchase price**.
3. After selecting a template, configure the electricity price as prompted.

For more details about configuration, see [7.11.4 Example of Configuring an Electricity Price](#).

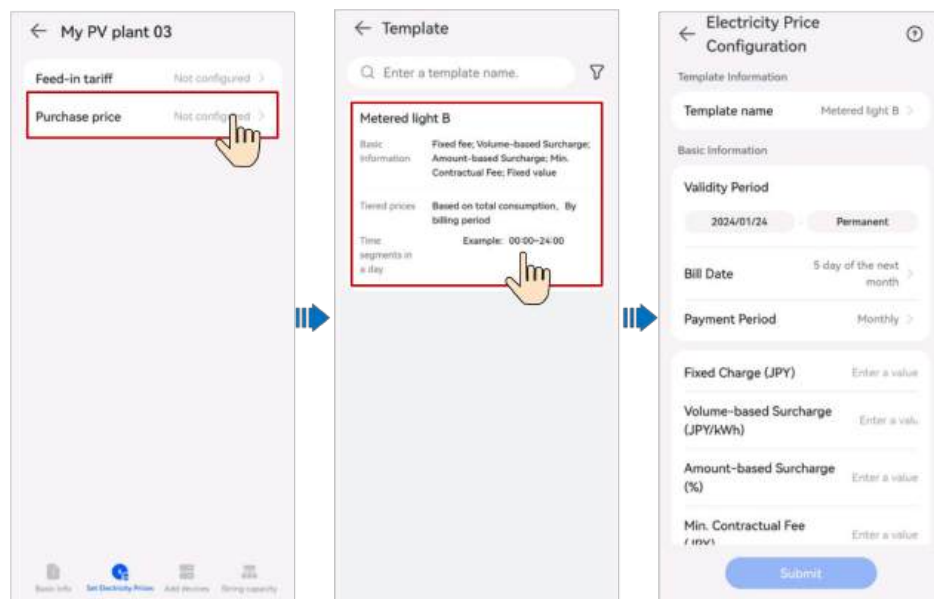

### NOTE

- Select an appropriate electricity price template based on the electricity fee calculation method in the purchase contract signed with the electric power company.
- If the electricity price calculation method in the available electricity price template is different from that in the purchase contract, contact the installer to add a template.

## 7.11.4 Example of Configuring an Electricity Price

### 7.11.4.1 Example of Configuring an Electricity Price (Scenario 1)

Keywords: TOU pricing, tiered pricing

1. **Table 7-7** is used as an example to obtain the following information by analyzing the electricity price solution:
  - The electricity price changes with time segments in a day.
  - The current electricity price depends on the electricity consumption. The tiered pricing is adopted for all time segments in a day.

**Table 7-7** Residential electricity price list 1

Price Type		Unit Price (CNY/kW)
Tier 1 (0-260 kW)	Peak hours	1
	Shoulder hours	0.65
	Off-peak hours	0.35
Tier 2 (261-600 kW)	Peak hours	1.2
	Shoulder hours	0.7
	Off-peak hours	0.4
Tier 3 (> 601 kW)	Peak hours	1.3
	Shoulder hours	0.95
	Off-peak hours	0.6
Note: <ul style="list-style-type: none"> <li>● Peak hours (14:00-17:00; 19:00-22:00)</li> <li>● Shoulder hours (8:00-14:00; 17:00-19:00; 22:00-24:00)</li> <li>● Off-peak hours (00:00-8:00)</li> <li>● For tiered pricing, the total volume of electricity consumption will be reset monthly. The data of one month will not be carried over to the next month.</li> </ul>		

2. Filter out the electricity price template based on the analysis result in Step 1.

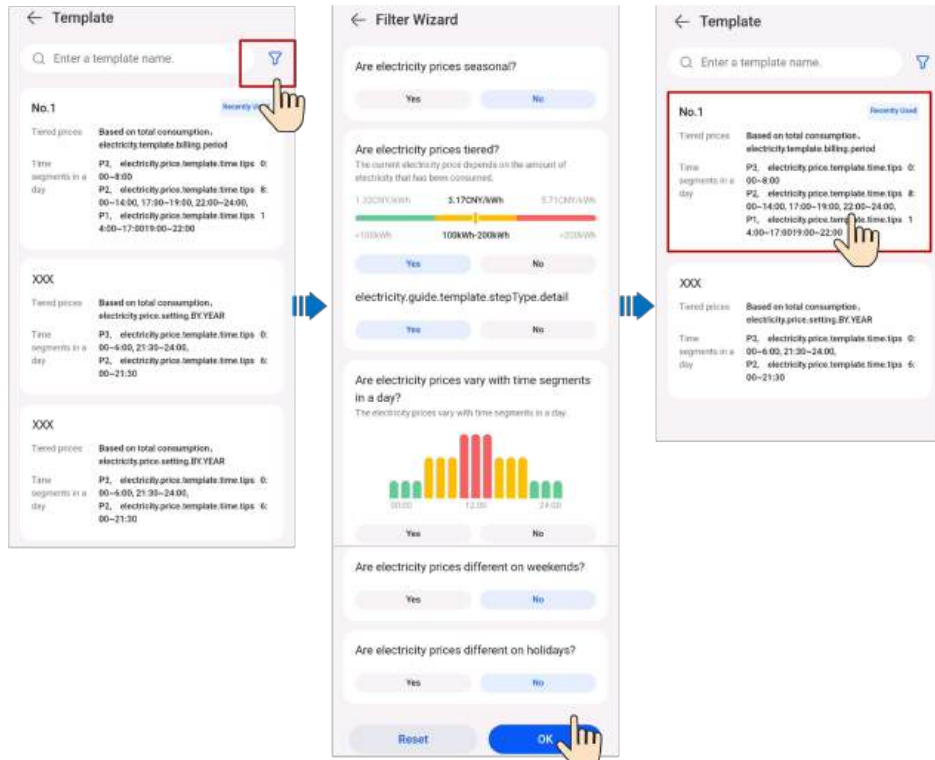

3. After the template is selected, fill in the electricity price information according to the contract.

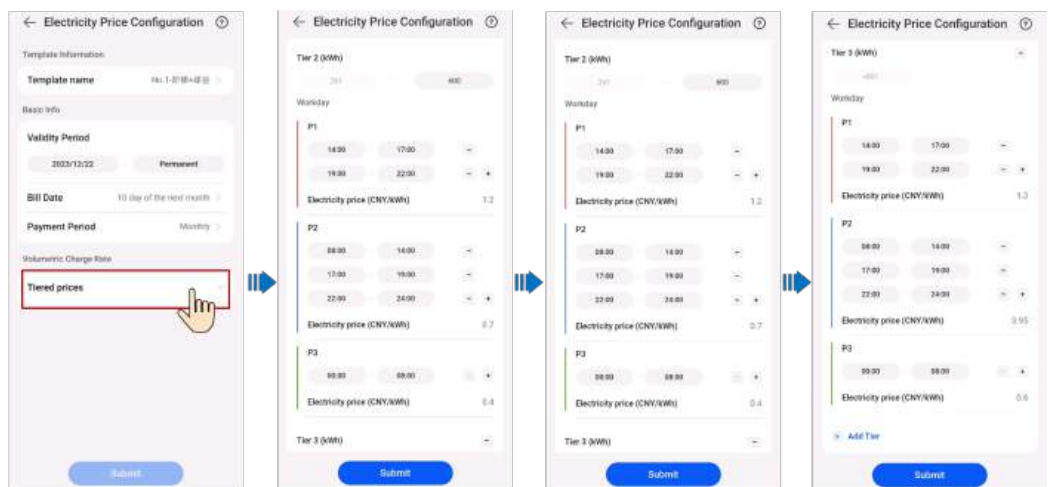

### 7.11.4.2 Example of Configuring an Electricity Price (Scenario 2)

Keywords: pricing by season, tiered pricing, extra fee based on volumetric charge, min. contract fee

1. **Table 7-8** is used as an example to obtain the following information by analyzing the electricity price solution:
  - The electricity price varies with seasons.
  - The current electricity price depends on the electricity consumption. The tiered pricing is adopted for all time segments in a day.

**Table 7-8** Residential electricity price list 2

Price Type	Unit Price	
Basic fee	60 (A)	1700 JPY/month
Volumetric charge rate (summer)	Tier 1 (0–120 kWh)	30 JPY/kWh
	Tier 2 (121–300 kWh)	36 JPY/kWh
	Tier 3 (> 301 kWh)	40 JPY/kWh
Volumetric charge rate (other seasons)	Tier 1 (0–120 kWh)	25 JPY/kWh
	Tier 2 (121–300 kWh)	28 JPY/kWh
	Tier 3 (> 301 kWh)	35 JPY/kWh
Minimum monthly fee	320 JPY	
Fuel cost adjustment	-	6 JPY/kWh
Renewable energy regulation	-	3 JPY/kWh
<p>Note:</p> <ul style="list-style-type: none"> <li>• Summer: May to October</li> <li>• Other seasons: January to April, November, and December</li> <li>• For tiered pricing, the total volume of electricity consumption will be reset monthly. The data of one month will not be carried over to the next month.</li> </ul>		

2. After selecting a template based on the analysis result in Step 1, fill in the electricity price information based on the contract.

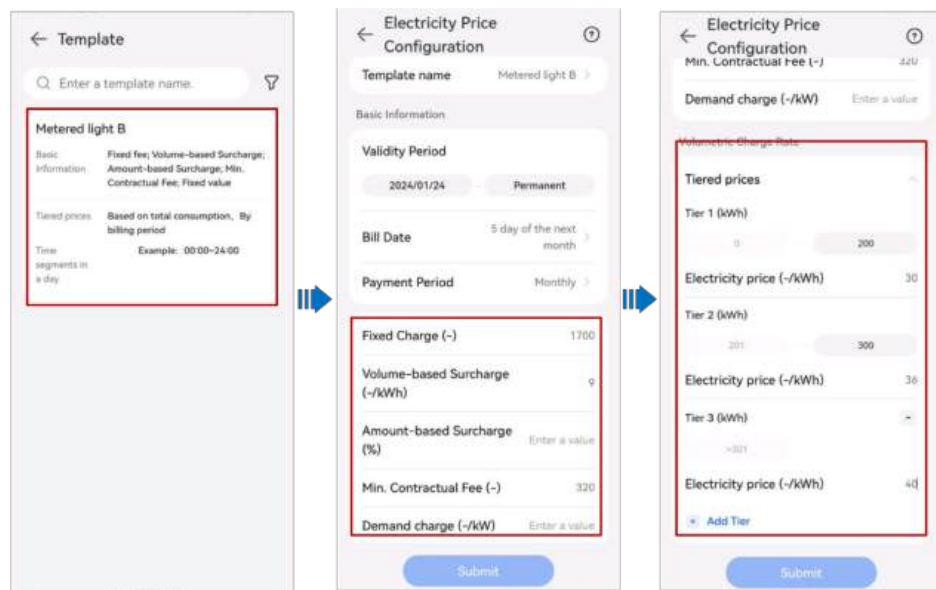

### 7.11.5 More Operations

### 7.11.5.1 Applying the Purchase Prices to Other Plants

1. Choose **Me > Plant management** on the home screen of the app and tap the target plant in the plant list.
2. Choose **Set Electricity Prices > Purchase price**.
3. Select the target electricity price and choose : > **Apply to Other Plants**.
4. Select the target plant and apply the price configuration to the plant as prompted.

### 7.11.5.2 Setting Holidays

Log in to the [FusionSolar SmartPVMS](#), choose **Plants > System Configuration > Set Holidays**, and set the parameters as prompted.

### 7.11.5.3 Adding a Purchase Price Template

Only installers can add purchase price templates. Log in to the [FusionSolar SmartPVMS](#) and choose **Plants > System Configuration > Set Electricity Prices** to add templates as prompted.

## 7.12 Processing a Plant Migration Task

After the administrator creates a plant migration task, the owner user needs to approve the task in the app to complete the plant migration.

1. On the home screen, choose **Me > Message center > To-do tasks**.
2. In the task list to be approved, tap the plant migration task to be processed, and then tap **Process Request**.
  - If you agree to migrate the plant, tap **Approve** to start the migration.
  - If you do not agree to migrate the plant, tap **Reject**.

#### NOTE

When you migrate a plant, your personal account and associated plants will also be migrated to the new company.

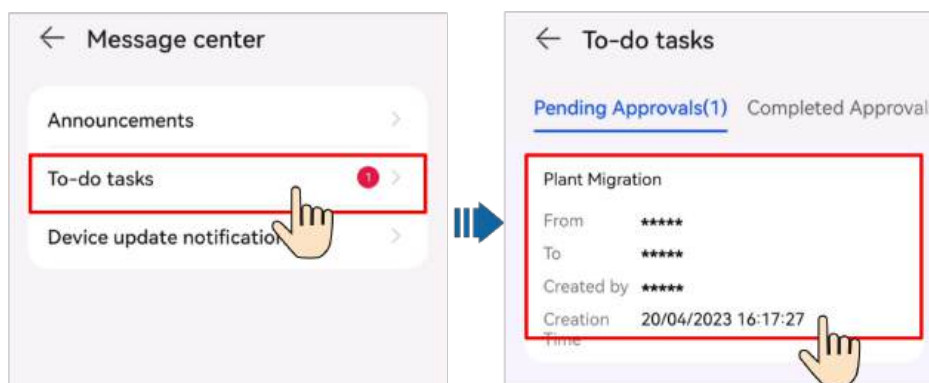

## 7.13 Processing an Upgrade Task

After the management system pushes a device version upgrade message to an owner user, the owner user can process the upgrade task on the app.

1. On the home screen, choose **Me > Message center > Device update notification**.
2. Tap the upgrade task to be processed to view the upgrade details.
  - If you agree to upgrade the device, tap **OK** to start the upgrade.
  - If you do not agree to upgrade the device, tap **Cancel** to cancel the upgrade task.

 **NOTE**

A discarded task cannot be restarted. If the device still needs to be upgraded, contact the installer to create an upgrade task again.

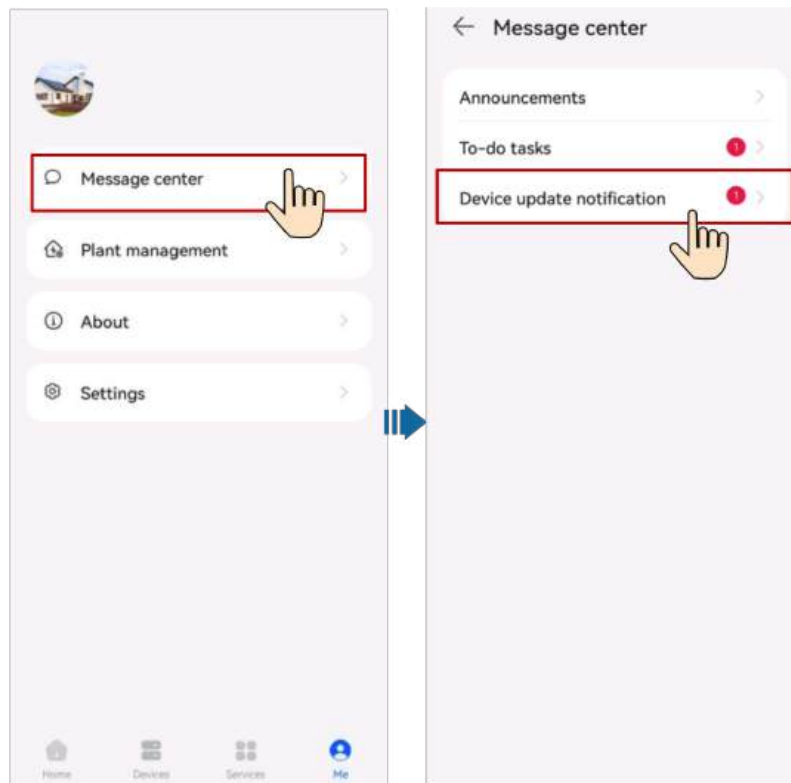

## 7.14 Log Export

On the home screen, tap **Me > About**.

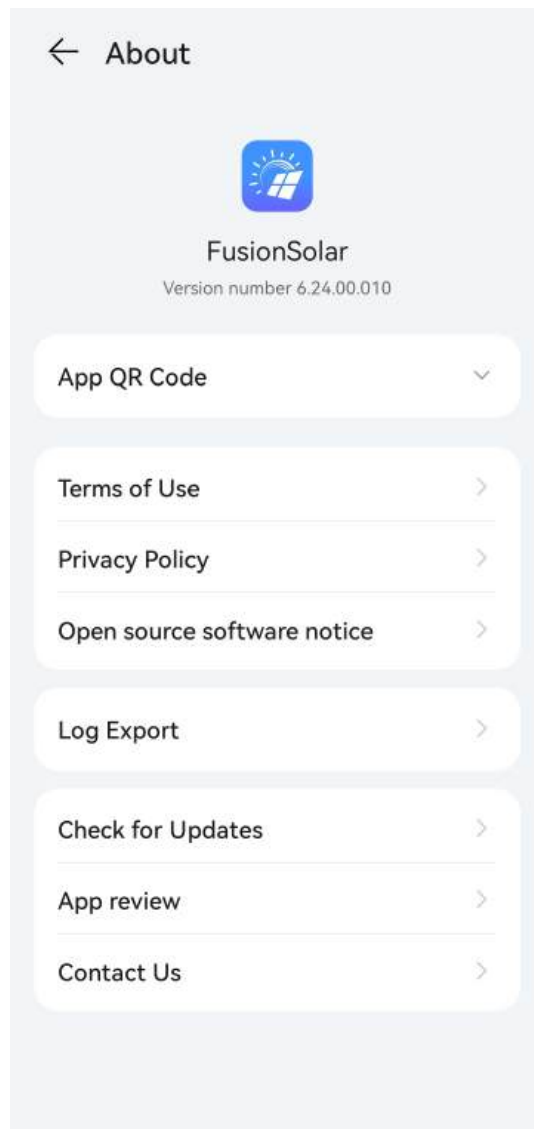

Tap **Log Export** to send logs to technical support engineers through Bluetooth, email, or other methods.

## 7.15 Permission Management

View and manage the system permissions and status required by the FusionSolar app.

---

### NOTICE

To protect your information security, disable the permissions after using them.

---

### Procedure

1. Tap **Me > Settings > Permission Management** on the home screen.

- On the **Permission Management** screen, you can view and manage the system permissions and status required by the FusionSolar app.
- Enable or disable authorization: Touch the target permission and configure it as prompted.

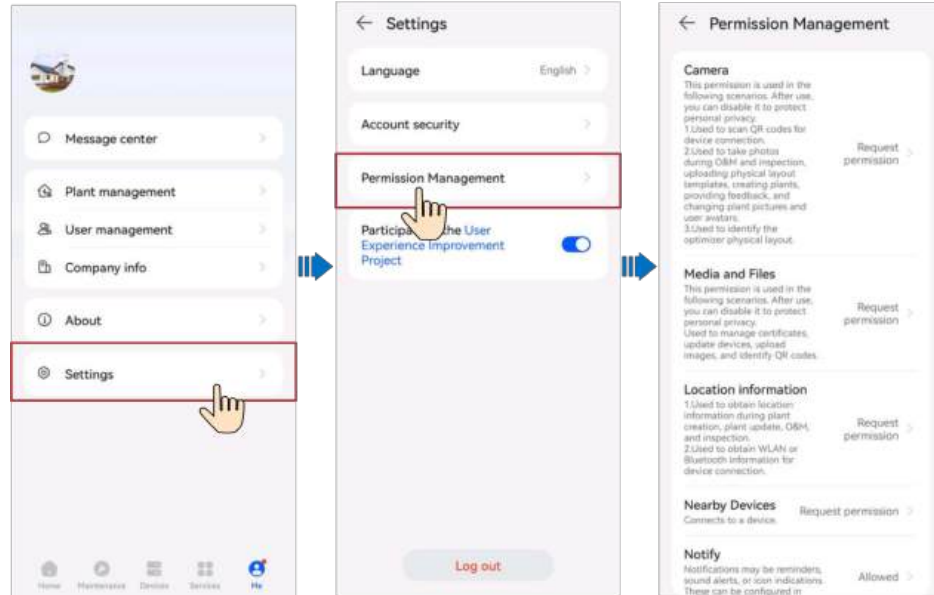

**NOTE**

- System permissions may vary based on Android or iOS.
- System permissions may vary based on roles.
- For details about required permissions, see **Me > About > Privacy Policy**.

## 7.16 Services

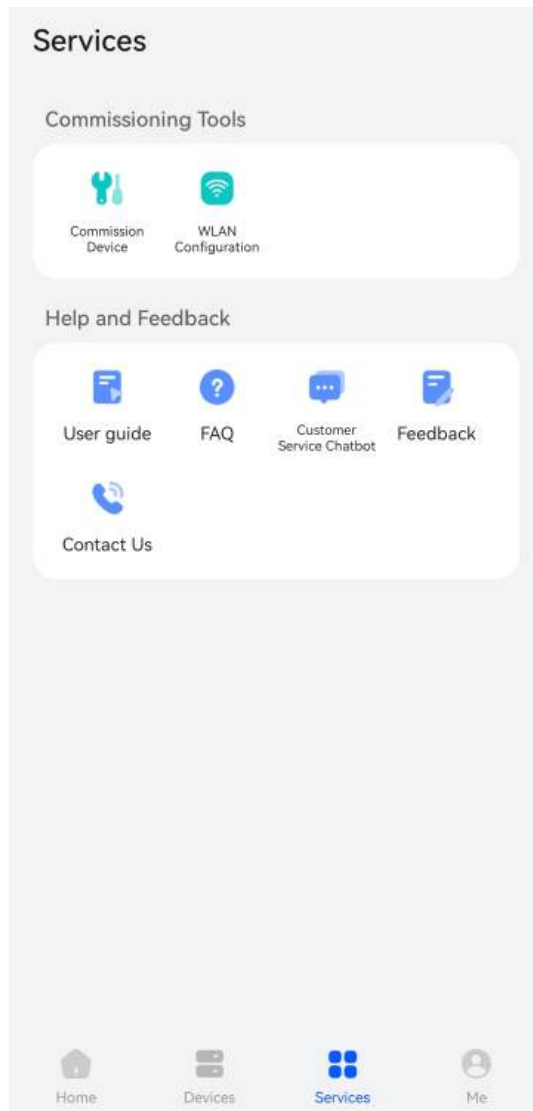

### Commissioning Tools

**Device Commissioning:** navigates to the device commissioning screen to perform operations such as deployment and commissioning, and local O&M.

**WLAN Configuration:** quickly configures the WLAN password of a device.

### Help and Feedback

Common functions include the user guide, FAQs, intelligent customer service, and feedback, which help you quickly understand device functions and solve problems.

1. **User Guide:** provides quick operation guide on functions as required.
2. **FAQs:** provides solutions to frequently asked questions.
3. **Feedback:** provides a feedback channel for users to help us improve user experience.

4. **Customer Service Chatbot:** helps users quickly solve problems through the one-to-one online customer service.
5. **Contact Us:** provides our contact information for users in case they have any questions about Huawei FusionSolar products.

# 8 Device Commissioning

---

For details, see the *FusionSolar App, SUN2000 App Device Commissioning Manual*.

## Obtaining the Device Commissioning Manual

Method 1: Visit the following link to obtain the commissioning manual.

<https://support.huawei.com/enterprise/en/doc/EDOC1100273864>

Method 2: Scan the QR code below to obtain the device commissioning manual.



# 9 Account Security Settings

---

Account security settings include verifying email address and changing the passwords. The email address verification is performed to reset the password if a user forgot the login password. If a password is disclosed or remains unchanged for a long time, you can change the password to improve account security.

## 9.1 Verifying an Email Address

After an account is successfully registered, you are advised to associate the account with your email address by verifying the email address. After the verification, you can reset your password using the email address if you forgot the password.

### Procedure

Method 1: When you log in to the system for the first time, the system automatically prompts you to verify your email address.

1. Enter the password for logging in to the FusionSolar app and tap **Next**.
2. After confirming that the email address is correct, tap **Send Code** and enter the verification code to verify the email address.
3. Tap **Confirm**.

#### NOTE

If the user does not verify the email address, this dialog box is displayed each time the user logs in to the FusionSolar app.

Method 2: Verify the email address on the **Personal Details** screen.

1. On the home screen, tap **Me** and tap your avatar.
2. Tap **Email**.

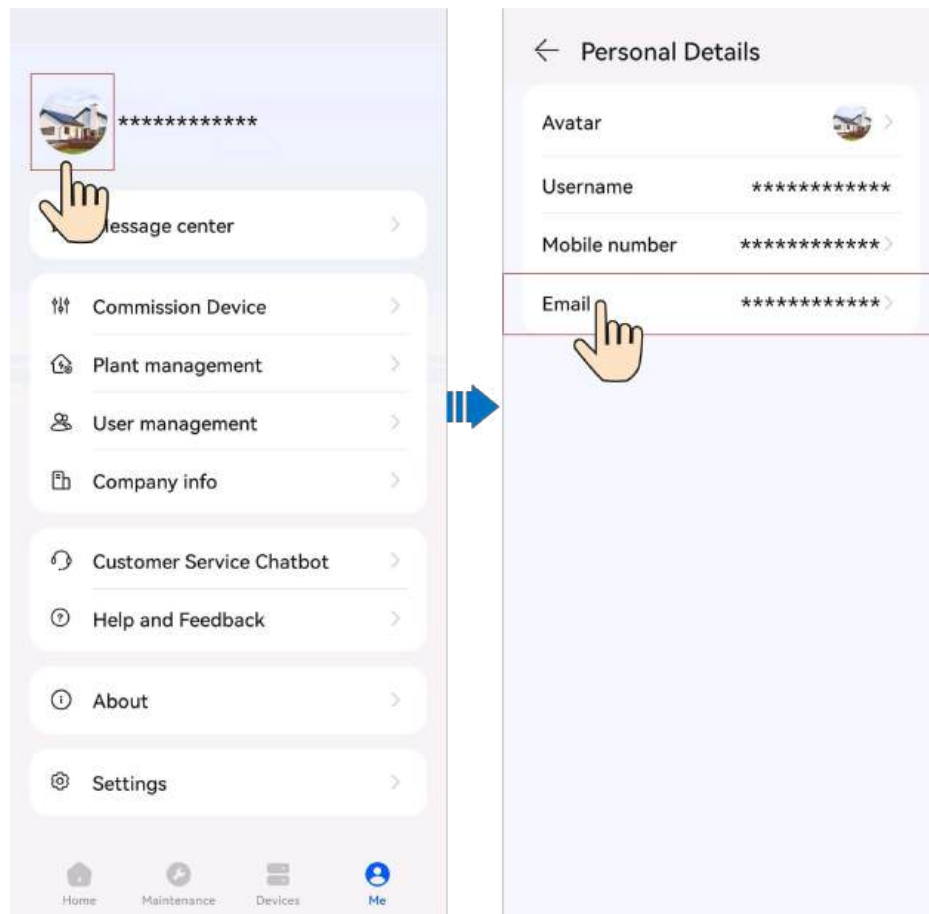

3. Enter the password for logging in to the FusionSolar app and tap **Next**.
4. After confirming that the email address is correct, tap **Send Code** and enter the verification code to verify the email address.
5. Tap **Confirm**.

#### NOTICE

- If the SMS verification code cannot be received, check whether the mobile number is correct and whether the user is suspended due to arrears.
- When modifying personal data, such as mobile numbers and email addresses, you are obligated to take considerable measures, in compliance with the laws of the countries concerned and the user privacy policies of your company, to ensure that the user's personal information is fully protected.
- To ensure the security of personal information, such as mobile numbers and email addresses, the data is anonymized on the screen, and HTTPS encryption transmission channels are used.

## 9.2 Changing Personal Passwords

1. On the home screen, choose **Me > Settings > Account security**.
2. Tap **Change password**.

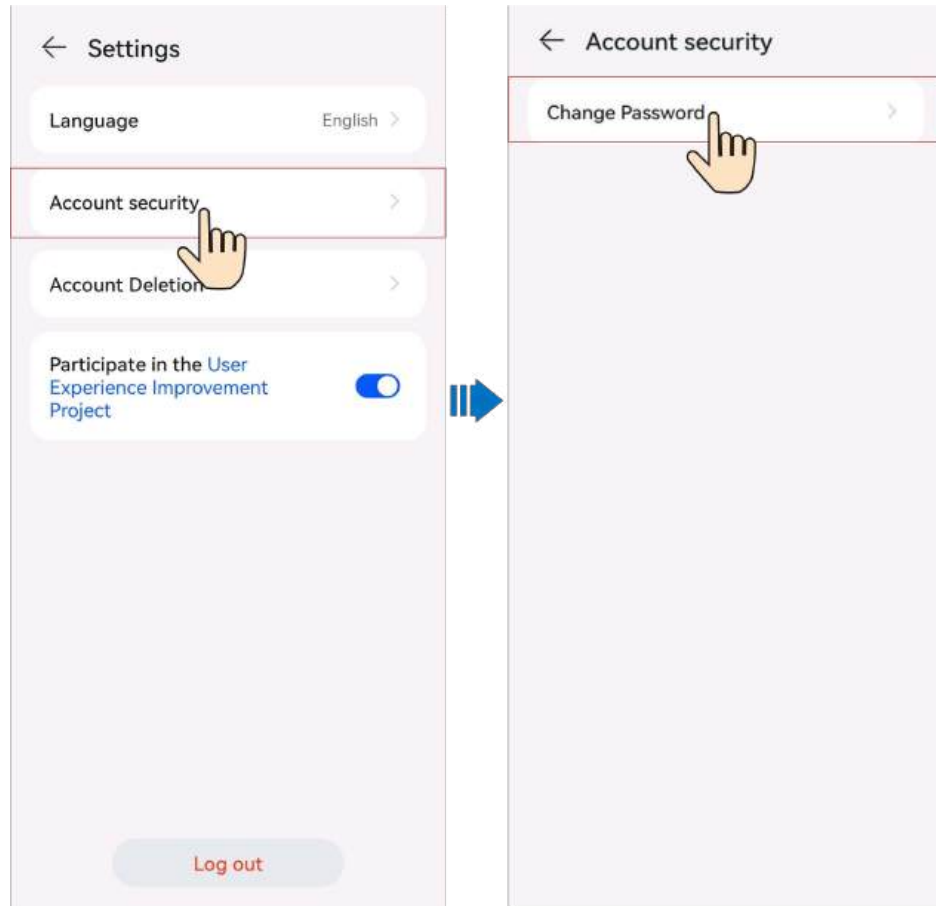

 NOTE

- For security purposes, you are advised to change the password periodically (for example, every three months).
- If you cannot change your password, contact the administrator.

## 9.3 Modifying Personal Information

When personal information such as mobile numbers and email addresses changes or needs to be supplemented, you can periodically maintain personal information on the **Personal Details** screen to ensure the accuracy of personal information.

### Procedure

1. On the home screen, tap **Me** and tap your avatar.
2. On the **Personal Details** screen, change the avatar and email address.

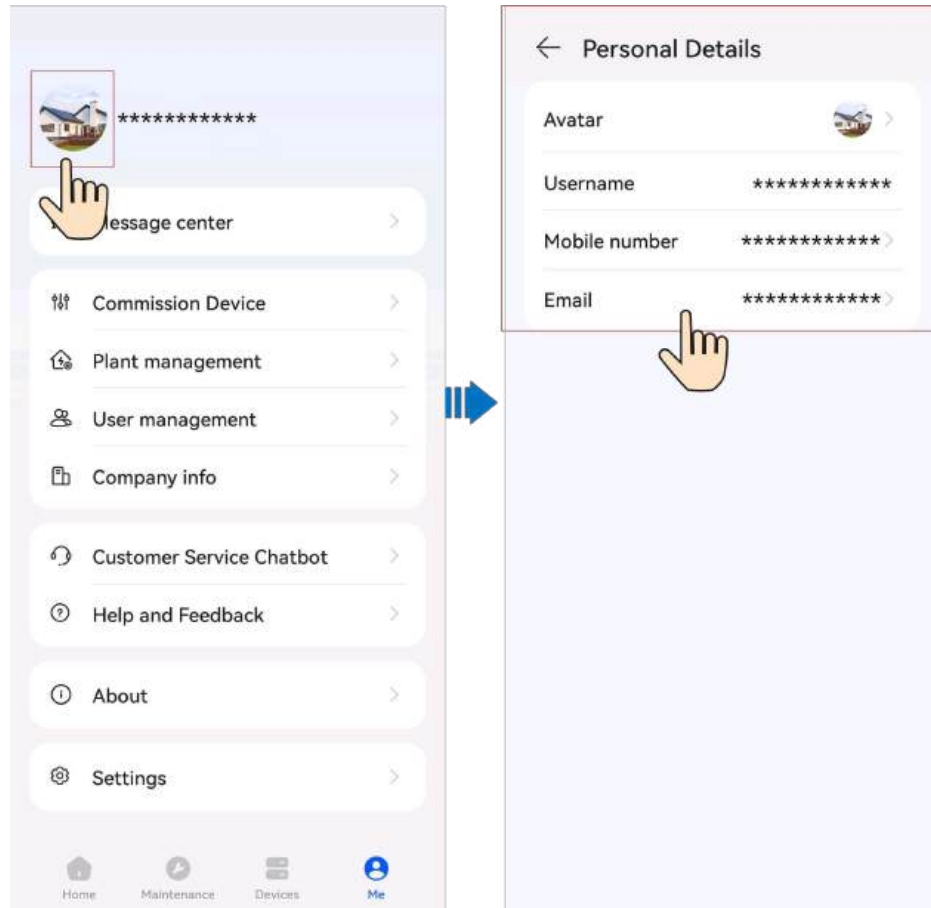

- Tap the avatar, and take a photo or select an existing picture from your album as the new avatar.
- Tap **Mobile number** or **Email** and change the mobile number or email address as prompted.

#### NOTICE

- When modifying personal data, such as mobile numbers and email addresses, you are obligated to take considerable measures, in compliance with the laws of the countries concerned and the user privacy policies of your company, to ensure that the user's personal information is fully protected.
- To ensure the security of personal information, such as mobile numbers and email addresses, the data is anonymized on the screen, and HTTPS encryption transmission channels are used.

# 10 FAQs

---

## 10.1 Resetting a Password Using the Associated Email Address

### Prerequisites

The user has an associated and [verified email address](#). If the system displays a message indicating that the contact information is not verified, contact the installer to reset the password.

### Procedure

1. On the app login screen, tap **Forgot password?**

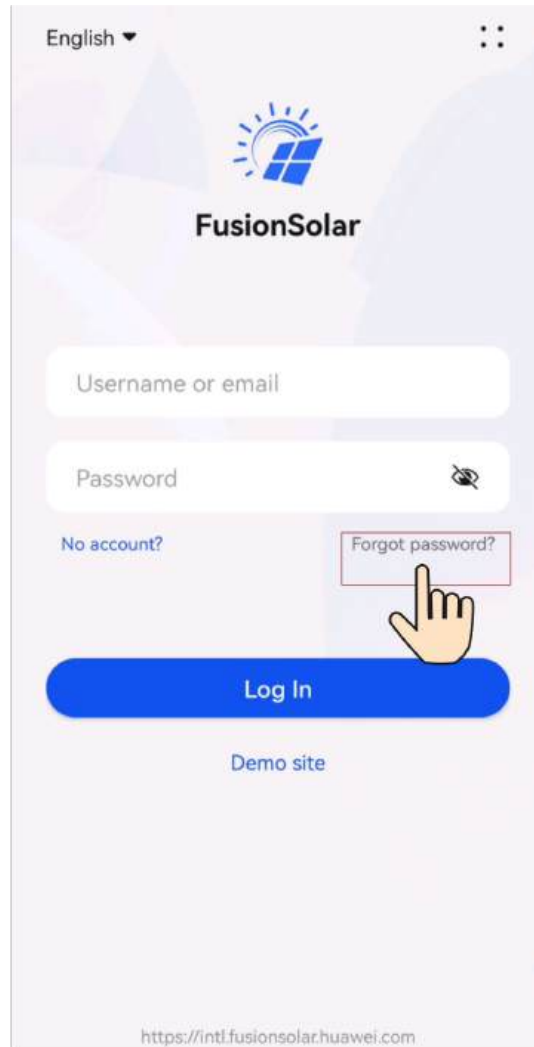

2. Enter the email address associated with the account and the verification code, and tap **Next**.
3. Tap **Send Code** and enter the verification code to verify the email address.
4. Tap **Next**.
5. Enter the new password as prompted and tap **Confirm**.

## 10.2 Resetting a User Password

When a user cannot reset a password by tapping **Forgot password?**, the user can authorize the installer to log in to the app to reset the password.

### Procedure

1. Log in to the app as an installer and tap **Me** on the home screen.
2. Tap **User management**.
3. Select a user, tap; and tap **Reset Password**.
4. On the **Reset Password** screen, set the new password.

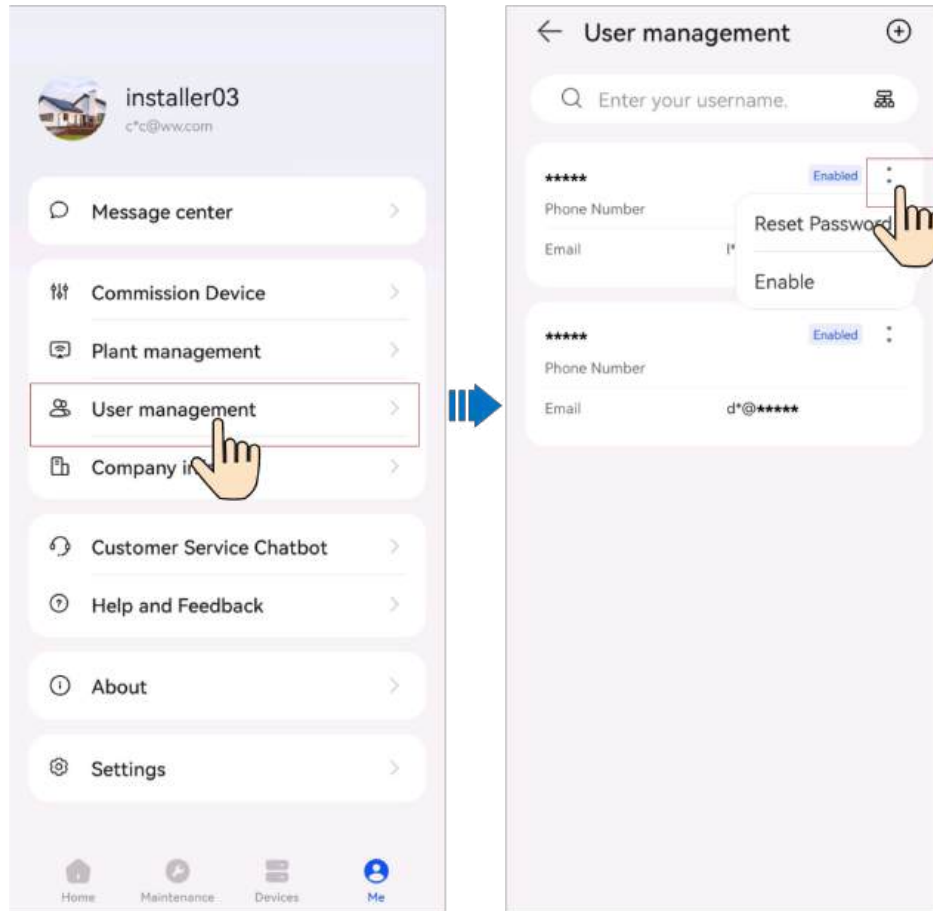

## 10.3 Troubleshooting the No Data Fault After a User Logs In to App

### Cause

The app is an earlier version and needs to be upgraded to the latest version.

### Procedure

Method 1: Download and install the app from the app store.

- Huawei mobile phone users: Search for **FusionSolar** in Huawei AppGallery.
- iPhone users: Search for **FusionSolar** in the App Store.
- Other mobile phone users: Select method 2.



Method 2: Scan the QR code to download and install the app.



 NOTE

Users who select method 2 can select the download method based on the mobile phone type.

- Huawei mobile phone users: Download from Huawei AppGallery.
- Non-Huawei phone users: Download on a browser.

When you select **Download via the Browser**, if a security warning message is displayed indicating that the app is from an external source, tap **ALLOW**.

## 10.4 Handling a Network Exception When a User Logs In to App

### Solution

- Check whether the WLAN or mobile network connection is normal.
- Check whether the account is forcibly logged out on the FusionSolar SmartPVMS.
- Check whether the network permission is enabled for the app.
- If the account and network are normal and the permission has been granted, tap **::** in the upper right corner of the login screen, tap **Log Export**, and contact technical support.

## 10.5 How Do I Reset the Default Password of a Charger Using an RFID Card When I Forgot the Password?

### Precautions

- This operation will reset both the WLAN password and login password. The charger login password will be reset to Changeme. The WLAN connection password will be reset to the initial password.
- Before resetting the password, ensure that the charger is in the **No Car Connected**, **Faulty**, or **Alarms** state.

### Procedure

1. Swipe the card for five consecutive times (wait until the indicator flashes blue before you swipe the card again). Then, the indicator on the charger is steady white for 3s and the charger enters the swipe protection state. Stop swiping the card now.

 NOTE

- When swiping the card consecutively, keep the intervals within 5s.
  - If you swipe your card in the swipe protection state, the swipe protection time will start again.
2. After 3s, the indicator flashes white fast for 20s. If you swipe the card again within this 20s, the indicator turns off and pulsates after 3s, indicating that the charger password has been successfully reset.

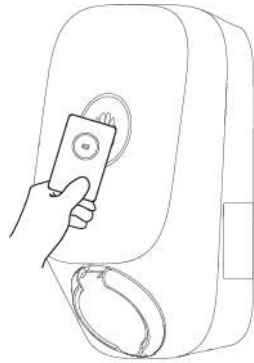

## 10.6 How Do I Connect to a Charger When I Cannot Log In to the FusionSolar App Due to Poor Network Connection?

 NOTE

Before connecting to the WLAN of the charger, disable the mobile network function and ensure that the mobile phone cannot connect to the Internet. When connecting to the WLAN of the charger, enable the WLAN as prompted.

1. On the app login screen, tap **:: > Commission Device**.
2. Connect to the WLAN of the charger as prompted.

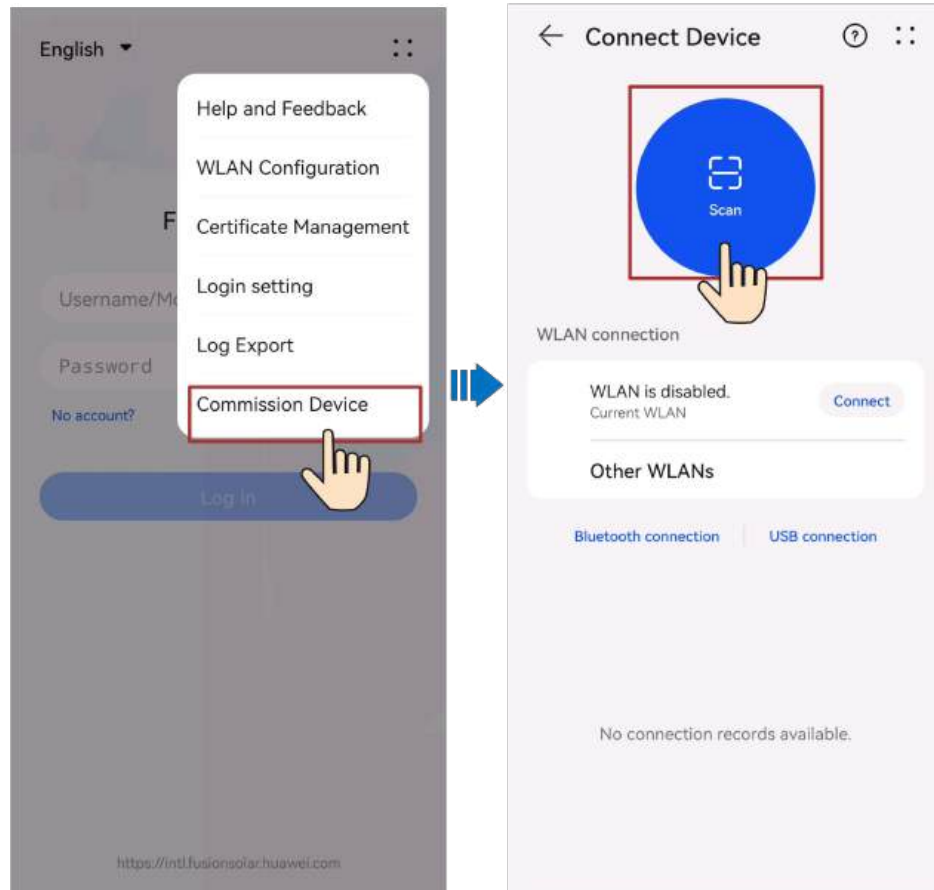

## 10.7 What Should I Do If the Charging Connector Cannot Be Removed From the Charger?

### Scenario 1: Charging Connector Cannot Be Removed After an AC Power Outage

Solution: Remove the charging connector only after the AC power supply is recovered and the charger enters the standby state.

### Scenario 2: Charging Connector Locked

Solution:

1. Unlock the charging connector on the app.
  - a. On the **Overview** screen, tap **Settings**.
  - b. Disable **Lock Charging Connector**.
2. Insert the charging connector back into the charger. When you hear a **click**, remove the charging connector.

## 10.8 What Should I Do If the App Cannot Identify the Charger?

Upgrade the app to the latest version and reconnect to the charger.

## 10.9 Upgrading the Charger Software Version

### Prerequisites

- You have obtained the upgrade package from your supplier or engineers. After the download is complete, use the digital certificate and verification tool available at Huawei technical support website to verify the digital signature of the software package.
  - a. Log in to Huawei enterprise technical support website (<http://support.huawei.com/enterprise>).
  - b. Browse or search for **PGP Verify**.
- You have copied the upgrade package to the storage directory of the mobile phone that connects to the charger.

### Procedure

1. On the home screen, choose **Maintenance > Upgrade Management**.

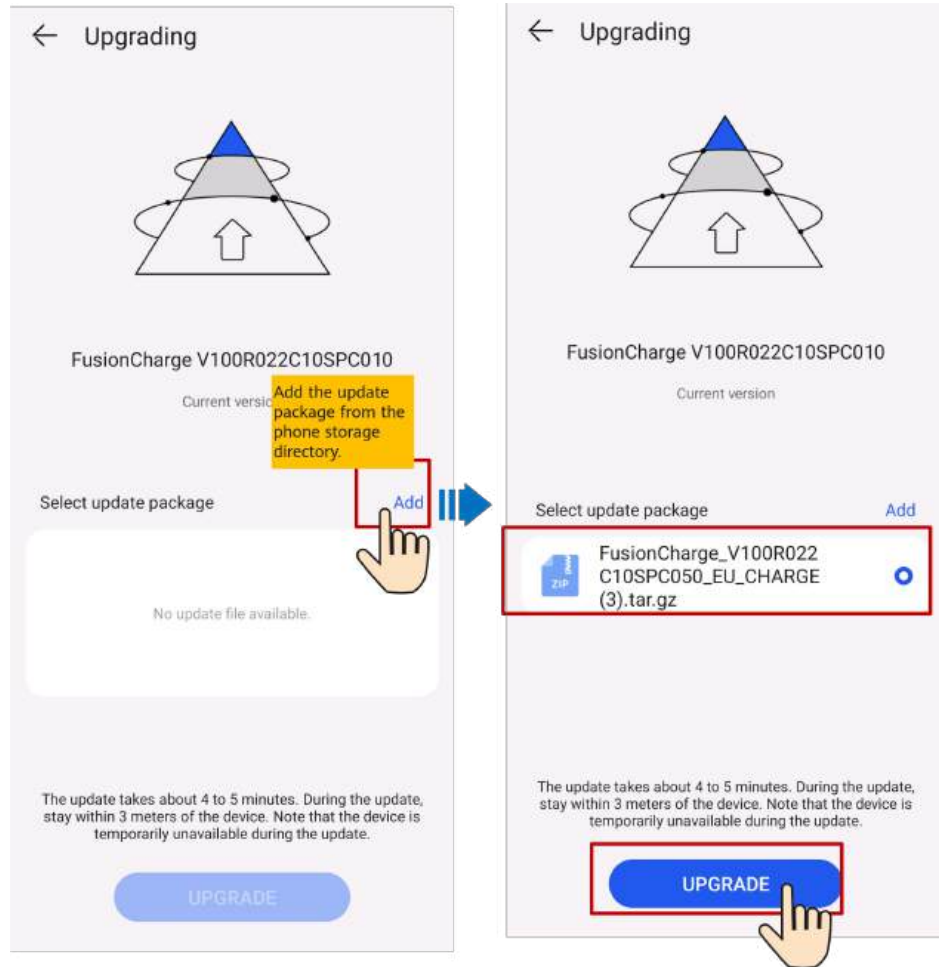

## 10.10 What Should I Do If the Upgrade Package Obtained from an iPhone Cannot Be Selected on the Upgrade Screen?

### Cause

In the iOS system, the upgrade package can be selected only from the software installation path. If the upgrade package is not in the software installation path, the upgrade cannot be performed. You need to place the upgrade package in the installation path before the upgrade.

### Procedure

Method 1: Share the upgrade package to the FusionSolar app.

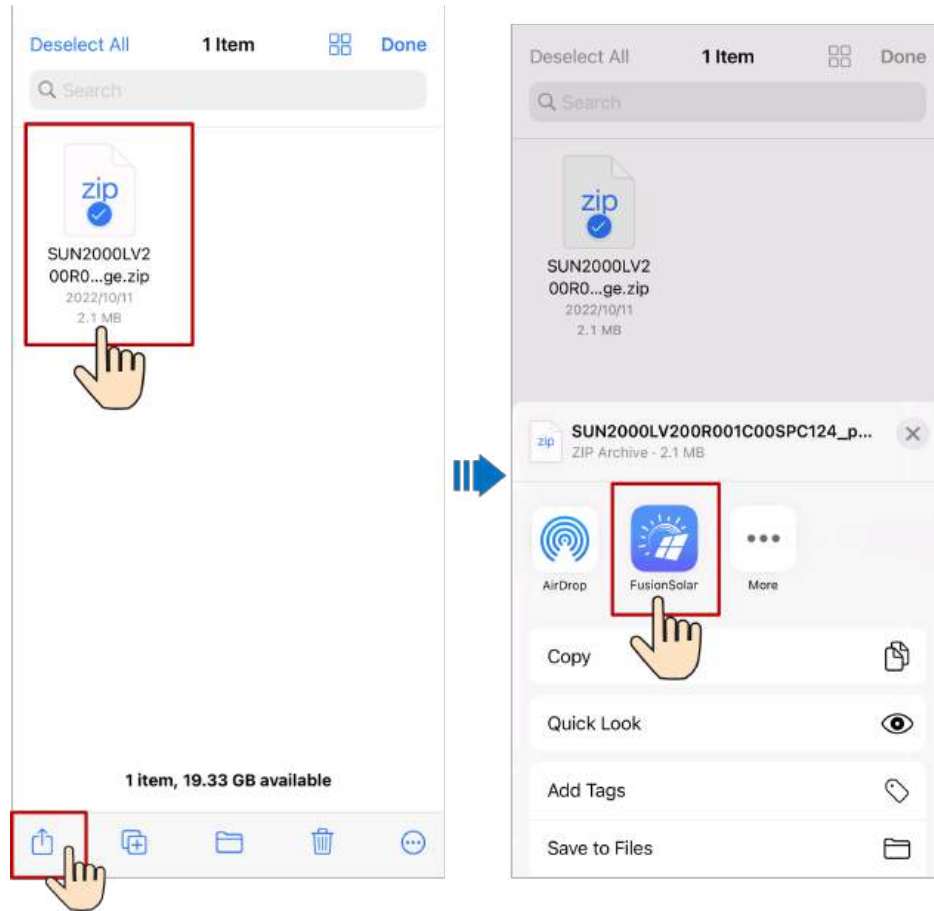

Method 2: Save the upgrade package to the specified path (FusionSolar/SolarMate/upGradePatch) of the FusionSolar app.

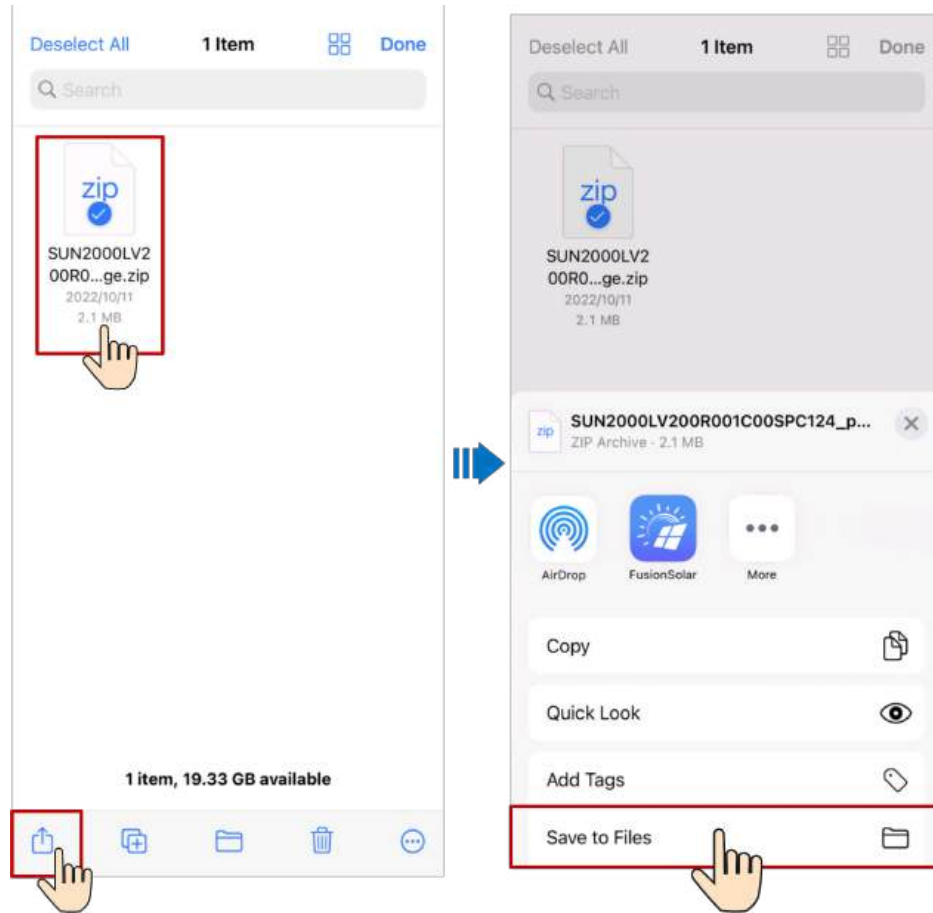

## 10.11 What Should I Do If an Offline or Faulty Charger Is Displayed in the Plant After the Charger Is Replaced?

### Cause

If the old charger is not deleted after the replacement, it will be displayed as offline or faulty. In this case, you need to unbind the old charger from the plant.

### Procedure

1. Choose **Me > Plant management** and tap the target plant.
2. Tap **Add devices**.
3. Tap  and select **Unbind Device** or **Delete Device** based on the site requirements.

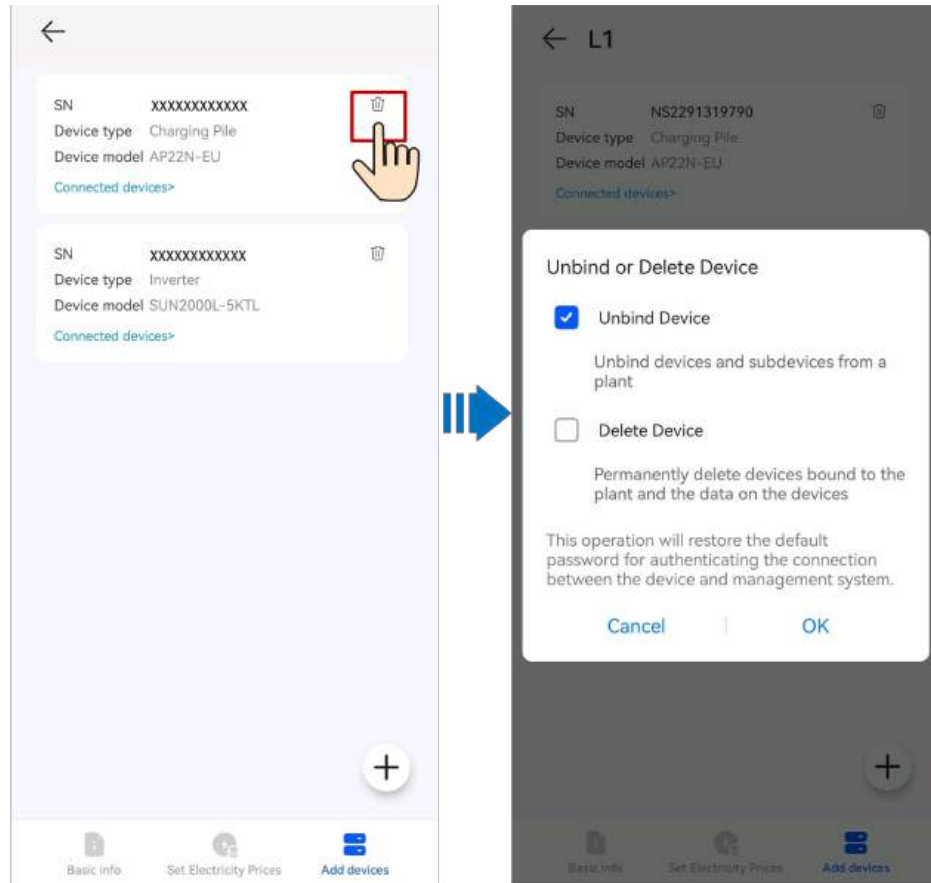

**NOTE**

- After a device is unbound, the running data of the device and its subdevices is stored in the database. The default data retention period is six months. To change the retention period, contact the system administrator.
  - If a device is rebound to a plant within the data retention period, the device inherits the retained data.
  - If a device is not bound to a plant within the data retention period, the data will be automatically deleted.
- After a device is permanently deleted, the running data of the device and its subdevices is deleted immediately. When the device is bound to the plant again, the running data of the device is not restored.

## 10.12 Why Is the Charger Displayed as Offline in the Management System after Factory Settings Are Restored?

### Cause



After the charger is restored to factory settings, the charger is disconnected from the management system. You need to unbind the charger from the management system and then bind it again.

## Procedure

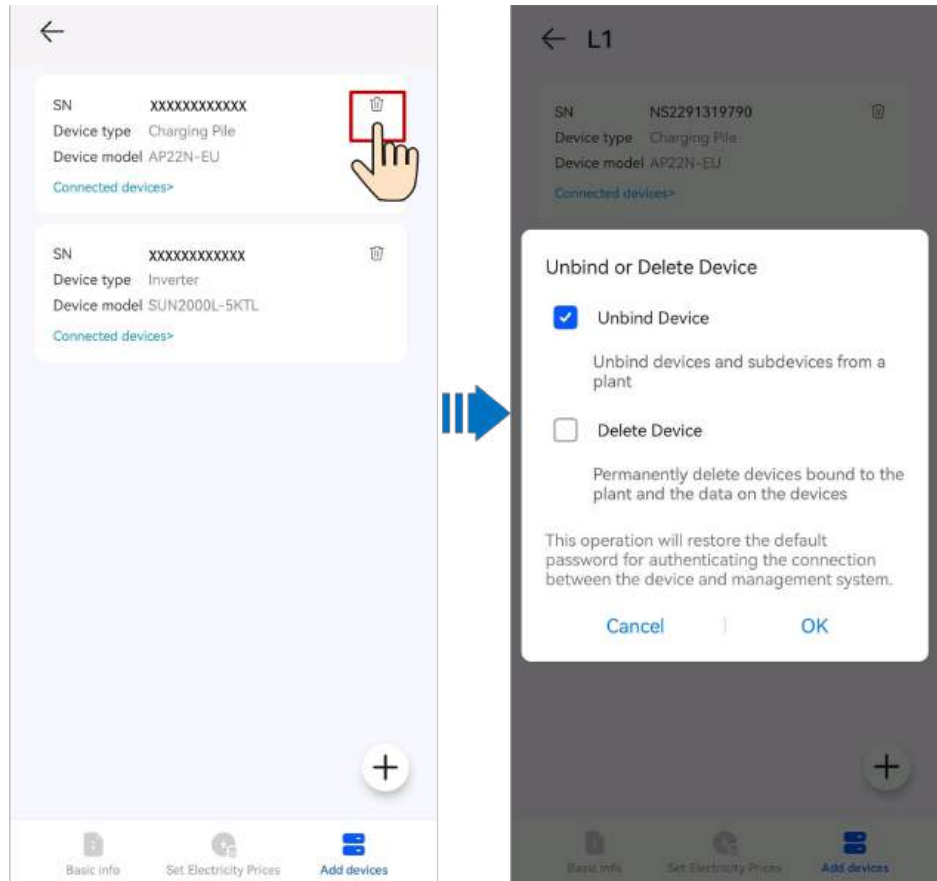
- Unbind a charger.
  - a. Choose **Me > Plant management** and tap the target plant.
  - b. Tap **Add devices**.
  - c. Tap  and select **Unbind Device** or **Delete Device** based on the site requirements.



### NOTE

- After a device is unbound, the running data of the device and its subdevices is stored in the database. The default data retention period is six months. To change the retention period, contact the system administrator.
  - If a device is rebound to a plant within the data retention period, the device inherits the retained data.
  - If a device is not bound to a plant within the data retention period, the data will be automatically deleted.
- After a device is permanently deleted, the running data of the device and its subdevices is deleted immediately. When the device is bound to the plant again, the running data of the device is not restored.
- Bind a charger.
  - a. On the **Me > Plant management** screen, tap the target plant.
  - b. Tap **Add devices** and then .
  - c. Tap  to scan the QR code on the device. Then, tap **Save**.

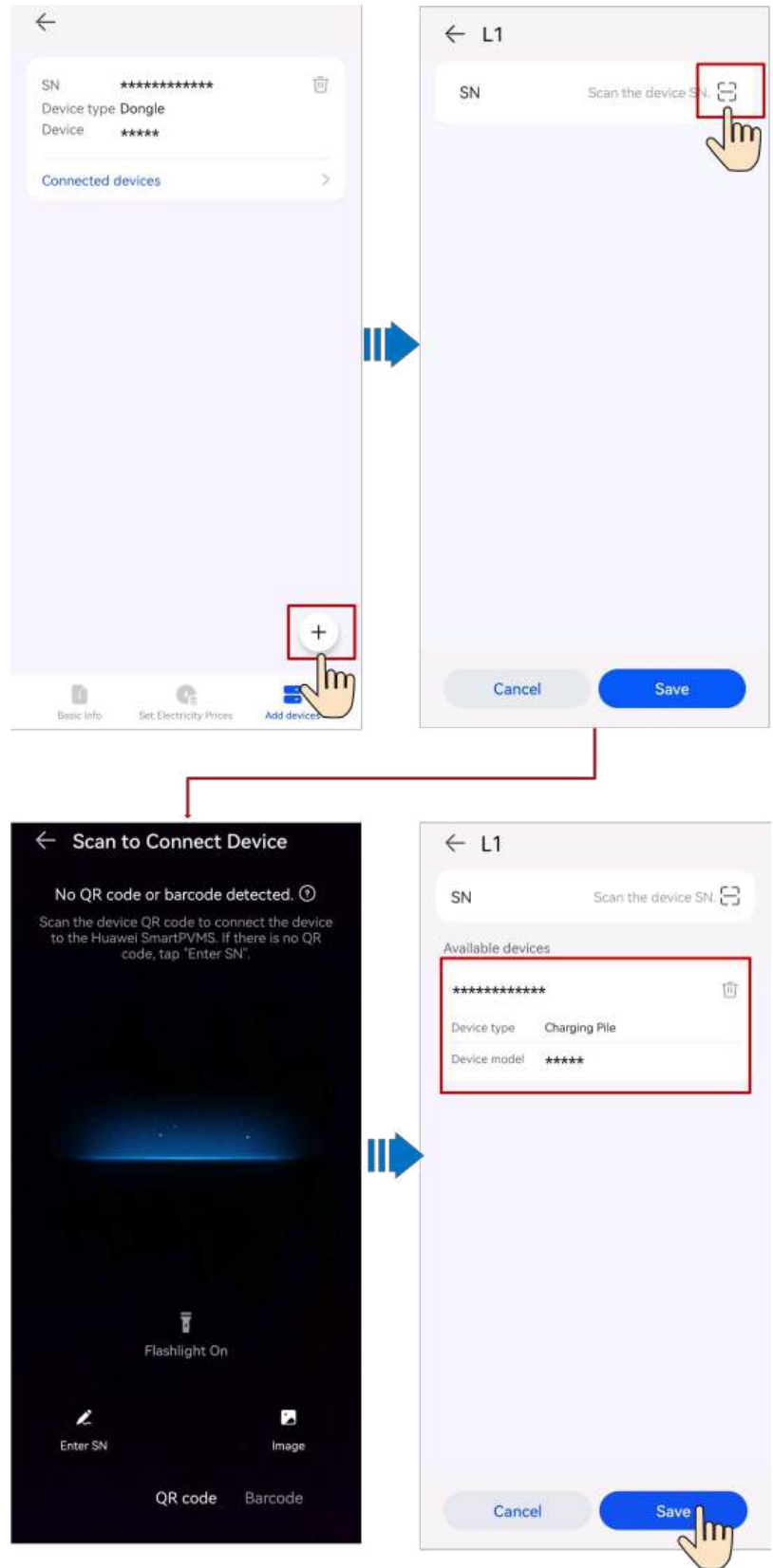

## 10.13 Why Is the Pairing Request Displayed Twice During Bluetooth Pairing?

When you pair the charger to your phone through Bluetooth, the Bluetooth pairing request is displayed twice.

This is normal. Please allow pairing each time the request is displayed.

## 10.14 How Do I Obtain a Registration Code?

### Context

If devices are connected to the management system through the SmartLogger or Smart Dongle, you need to enter the registration code when binding a plant.

### Procedure

1. Log in to the FusionSolar app and choose **Services** > **Device Commissioning** > .

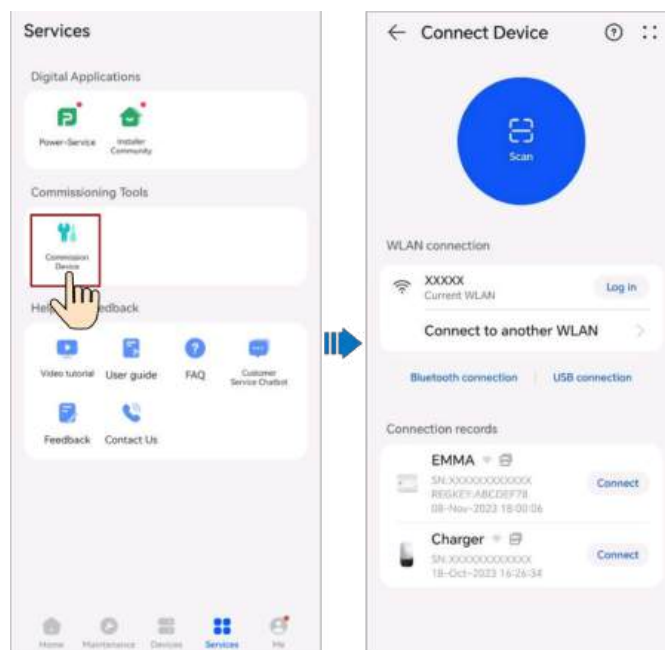

2. On the connection record screen, select the connection record of the target device and tap  to copy the registration code and device information.

## 10.15 What Should I Do If My Android Phone Fails to Connect to the WLAN After I Scan the QR Code?

### Symptom

After the device QR code is scanned using an Android phone, the **Device to use with** message is displayed. After **CONNECT** is tapped three times, the **The WLAN connection has changed. Try to connect to the system WLAN** message is displayed.

### Solution

- For Huawei mobile phones on Android 10 or later:
  - a. On the home screen of your mobile phone, tap **Settings > WLAN**.
  - b. Tap **More settings**.
  - c. Disable **WLAN+**.
- For other mobile phones:
  - a. On the home screen of your mobile phone, tap **Settings > WLAN**.
  - b. Tap the WLAN of the target device, select **FORGET** or **DELETE**, and scan the QR code to connect to the WLAN again.

#### NOTE

If the **This WLAN network has no Internet access. Connect anyway?** message is displayed when you connect to the built-in WLAN, tap **CONNECT**. Otherwise, you cannot log in to the system. The actual UI and messages may vary with mobile phones.

## 10.16 Obtaining a Physical Layout Template

Before creating a physical layout, you need to obtain a physical layout template for attaching optimizer labels.

You can obtain a physical layout template in either of the following ways:

- Method 1: Use the paper physical layout template delivered with the optimizers.
- Method 2: Log in to <https://solar.huawei.com>, choose **Download > Product Document > FusionSolar > Product > Smart PV Optimizer**, select the corresponding optimizer quick guide, and download and print the physical layout template.
- Method 3: Log in to <https://support.huawei.com/enterprise/en/index.html>, choose **FusionSolar > Smart PV Optimizer > SUN2000P** in the **Digital Power** module, select the corresponding optimizer quick guide, for example, [SUN2000-\(600W-P, 450W-P2\) Smart PV Optimizer Quick Guide](#), and download and print the physical layout template.

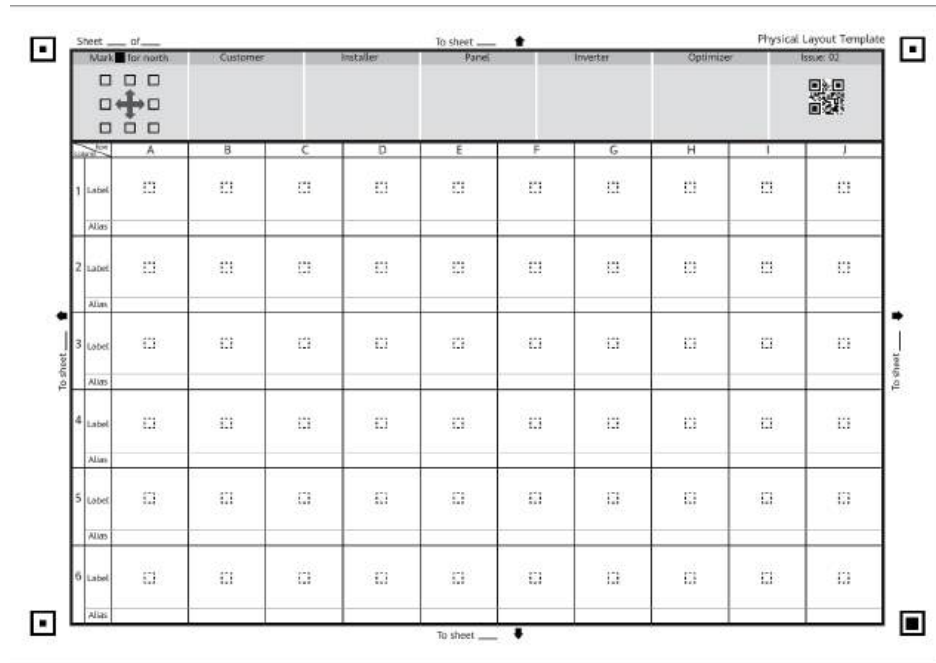

**NOTE**

You are advised to use the A4 glossy paper to print templates, which facilitates re-attaching if the label is incorrectly attached.

## 10.17 How Do I Invite a User to Register a FusionSolar Account?

Log in to the FusionSolar app as an installer and tap **Invite User** on the **Home** screen.

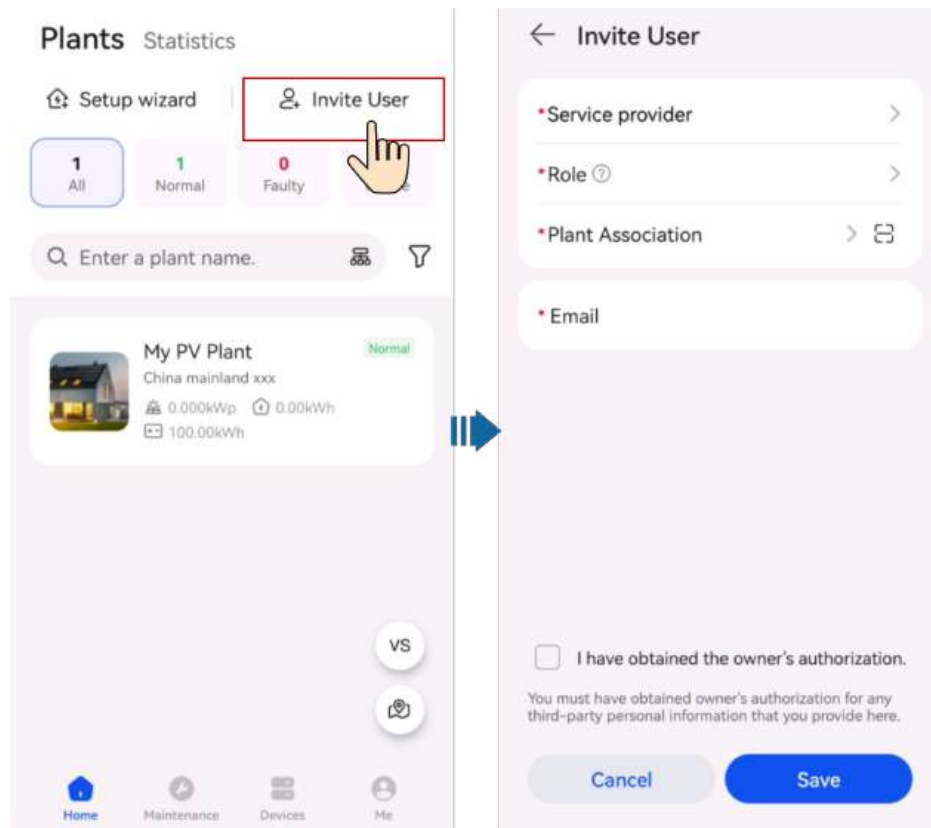

## 10.18 How Do I Register a FusionSolar Account?

- If self-service registration is not supported in your region, your installer needs to **create an account** for you and bind a plant. After the account is created, the system will send you the username and initial password by email.
- If self-service registration is supported in your region, your installer needs to initiate an **invitation**. After receiving an invitation email from the installer, you can **register an account** on the registration screen according to the instructions.

## 10.19 How Do I Add or Delete an RFID Card?

### Adding an RFID Card

1. On the charger screen, tap **Settings > Card Management**.
2. In the upper right corner of the **Card Management** screen, tap  and select a mode to add a card.
  - Swiping
    - i. After the indicator blinks white fast twice, place the ring pattern on the RFID card in the swiping area. If the indicator is steady white for 5s, the card is successfully swiped.
    - ii. Enter the user-defined card name and tap **OK**

**Figure 10-1** Swiping

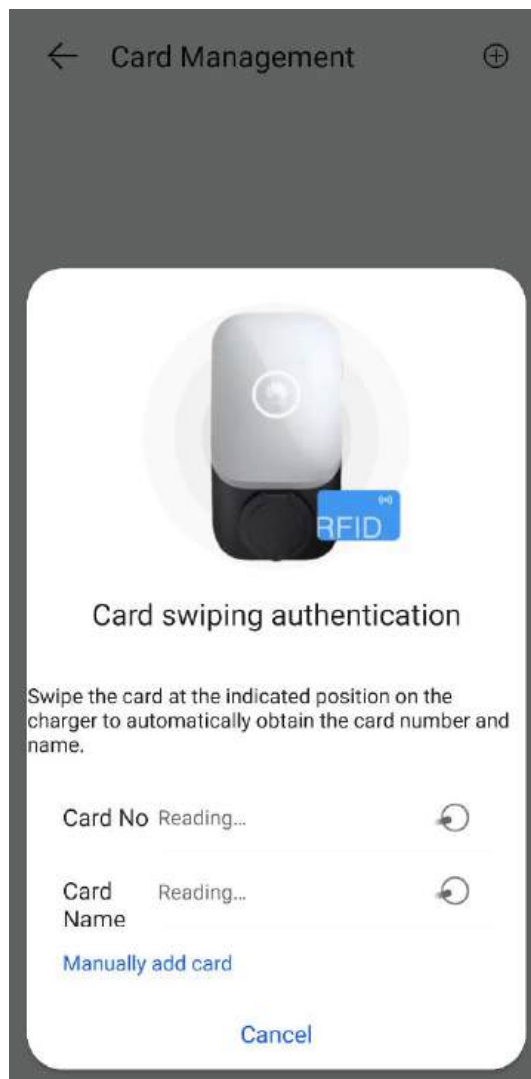

- Manually adding  
Enter the card number and user-defined name of the RFID card, and tap **OK**.

**Figure 10-2** Manually adding

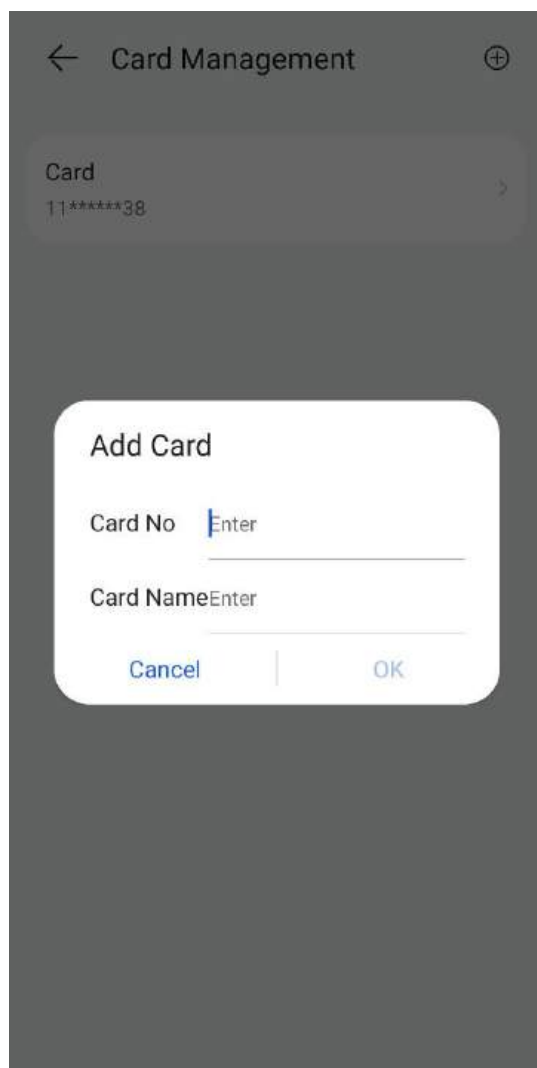

 **NOTE**

A maximum of eight RFID cards can be added to each charger.

After you add an RFID card, you can use the card to start or stop charging.

## Deleting an RFID Card

1. Select the card you want to delete, and then press and swipe left.
2. Tap  to delete the card.

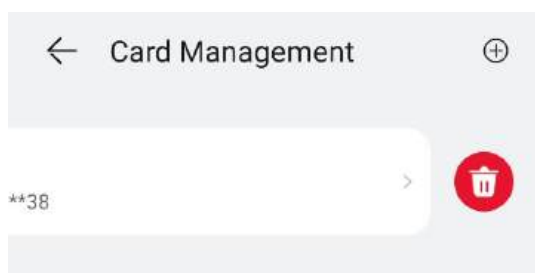

 NOTE

You cannot delete all added RFID cards. At least two RFID cards must be retained.

## 10.20 What Can I Do If the System Prompts Me to Reconnect to the Charger's WLAN Hotspot During Quick Settings?

### Cause

After setting routing parameters on some chargers, you need to restart the chargers for the settings to take effect. During the restart, the WLAN connection between your phone and the charger will become invalid.

### Solution

Reconnect to the charger's WLAN hotspot as prompted.

 NOTE

When reconnecting to the WLAN hotspot, you are advised not to stop the process of the FusionSolar app. Otherwise, you need to log in to the local commissioning screen of the charger again after the connection is set up.

## 10.21 Why Is the Display of Some Screens Incomplete or Abnormal After I Enlarge the Font Size on My Phone?

### Possible Causes

Some screens are not compatible with font adjustment. After the font size is set to a large value, the screen layout is abnormal.

### Solutions

Adjust the font of your phone to the standard or default font before browsing.

## 10.22 How Can I Change the WLAN Password of a Device?

1. Access the FusionSolar app and tap **:: > WLAN Configuration** on the login screen.
2. Connect to the WLAN of the device as prompted.
3. After the login is successful, the screen for resetting the WLAN password is displayed.

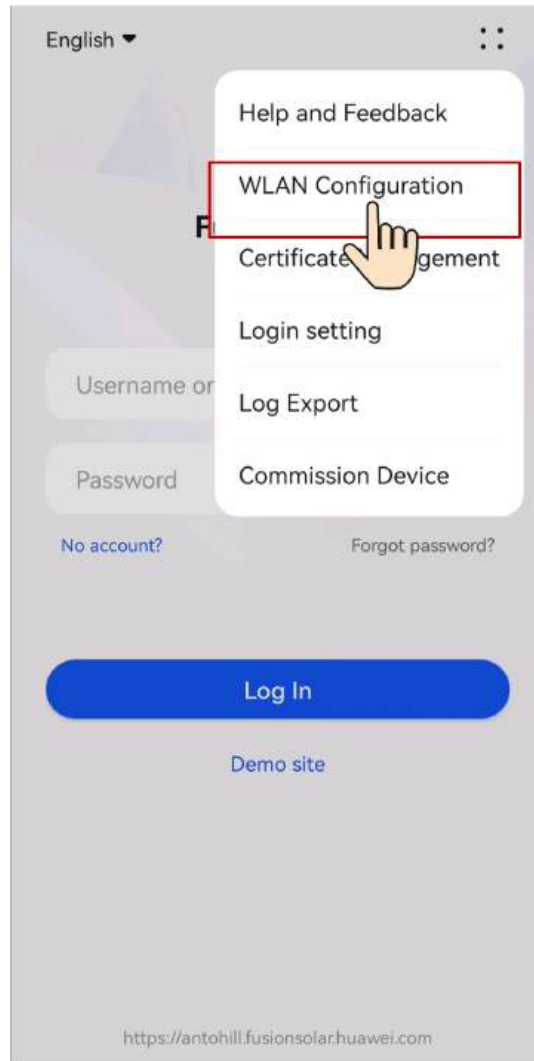

## 10.23 How Do I Navigate to the Device Local Commissioning Screen?

1. Log in to the FusionSolar app and choose **Services > Device Commissioning**.
2. Connect to the device WLAN as prompted.

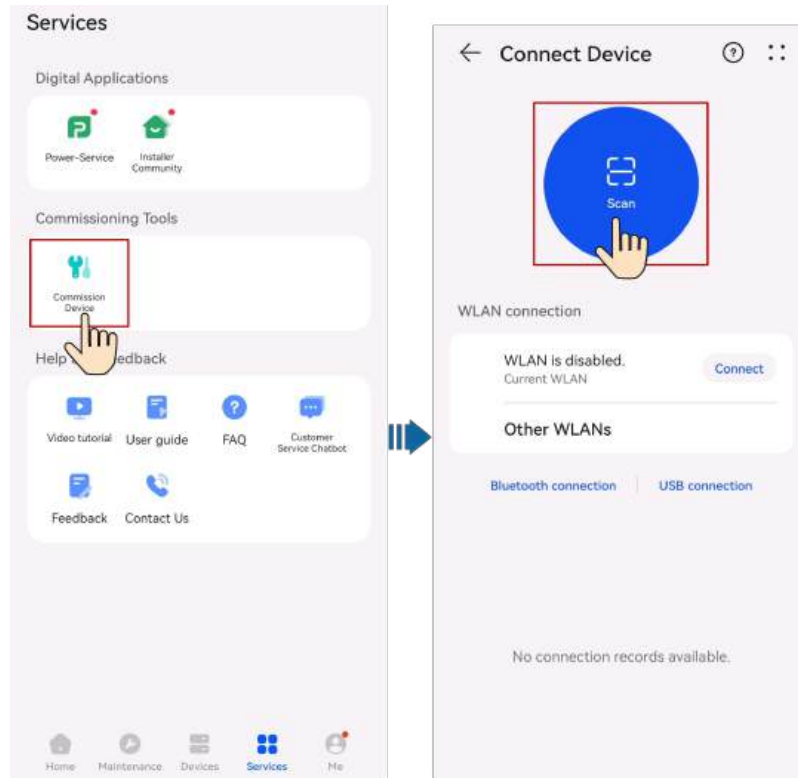

**NOTE**

- The last six digits of the device WLAN name are the same as the last six digits of the device SN.
  - For the first connection, log in with the initial password. You can obtain the initial WLAN password from the label on the device.
  - Ensure account security by changing the password periodically. Your password might be stolen or cracked if it is left unchanged for extended periods. If a password is lost, the device cannot be accessed. In these cases, the Company shall not be liable for any loss.
  - If the login screen is not displayed after you scan the QR code, check whether your phone is correctly connected to the device WLAN. If not, manually select and connect to the WLAN.
  - If the message **This WLAN network has no Internet access. Connect anyway?** is displayed when you connect to the built-in WLAN, tap **CONNECT**. Otherwise, you cannot log in to the system. The actual UI and messages may vary with mobile phones.
- Select a login user and enter the password.
  - Log in to the charger local commissioning screen as the **Owner** user.

**NOTE**

Change the initial password as prompted at the first login. If the system does not prompt you to change the password, use the initial password to log in.

- The initial password for a charger is **Changeme**.
- The initial password for a PV device is **00000a**.

## 10.24 What Should I Do If the Device Is Disconnected from the App When I Switch the Local Commissioning Screen to the Background?

### Symptom

During local commissioning, you may need to switch the app to the background (for example, uploading an upgrade package, uploading a photo, or scanning a QR code for WLAN connection). When you switch back to the app screen, a message is displayed, indicating that the device is disconnected from the app and you need to log in again.

### Solution

1. Tap **Settings > Apps & services**, and choose **App launch**.
2. Tap **Manage manually > Run in background** for the FusionSolar app.



#### NOTE

The menu name may vary according to the mobile phone brand.

## 10.25 How Can I Delete the Offline Legacy Devices in the FusionSolar SmartPVMS After I Use a New SmartGuard?

### Cause

After a new SmartGuard is used and a new EMMA is connected to the plant, the new EMMA automatically inherits the legacy devices of the old EMMA. In this case, you need to log in to the FusionSolar SmartPVMS to delete the offline legacy devices.

### Solution

1. Log in to the FusionSolar SmartPVMS as an owner.
2. Choose **Monitoring** > **Monitoring** from the main menu.
3. In the navigation pane, select a company or plant, and click the **Device Management** tab page.
4. Select the legacy devices to be deleted from the device list and click **Delete**.

## 10.26 What Can I Do If the Password Is Incorrect When I Connect to the Charger WLAN?

### Solutions

- Check whether the initial password has been changed.
- Check whether the eight-character initial password that you entered is correct. Identify the initial password on the device nameplate and enter the password again.
- You are advised to scan the QR code to connect to the charger.

# 11 Related Information

---

## 11.1 PV Power Generation Offsetting Carbon Emissions

A **100 MW** PV plant  
can avoid **6.41** tons of CO<sub>2</sub> emissions every year,  
which is equivalent to planting **87,602** trees  
(based on the assumption of 1350 sun hours per year)

### How to Calculate Equivalent Trees Planted

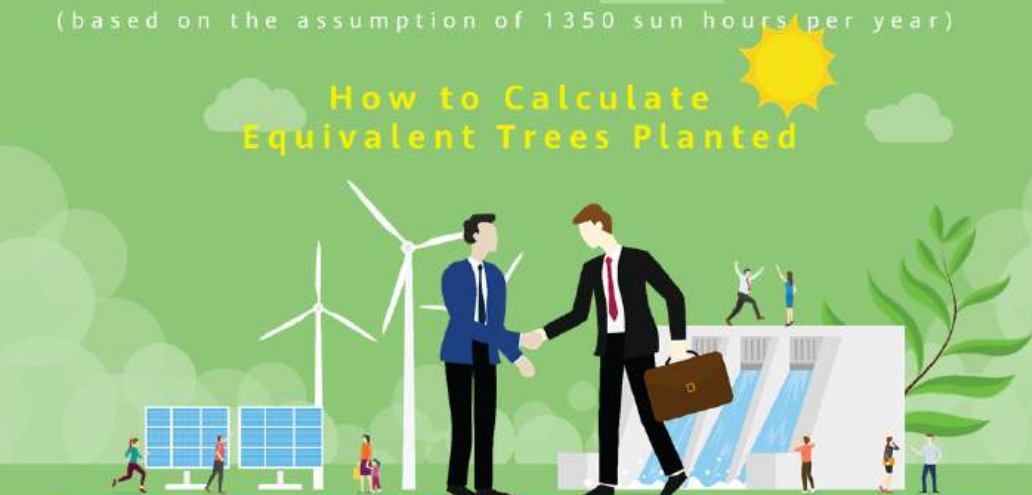

Greenhouse gas emissions have increased global temperatures, leading to serious consequences such as sea level rise and extreme weather events (floods, droughts, hurricanes, etc.).

Unlike thermal power plants, PV power plants generate electricity without CO<sub>2</sub> emissions, which is equivalent to planting trees.

How much CO<sub>2</sub> can be avoided for each kilowatt-hour of electricity generated from PV? How many trees are equivalent to the CO<sub>2</sub> emissions avoided?

**Fossil fuels saved and CO<sub>2</sub> emissions avoided \***

If fossil fuels are used, 1 kWh of electricity consumes 400 g coal (international standard value), generating about 475 g CO<sub>2</sub> (global average value). When PV is used, no CO<sub>2</sub> is emitted.

**Formula:**

- PV energy yield x Coefficient of CO<sub>2</sub> emissions avoided (0.475) = CO<sub>2</sub> emissions avoided (unit: kg)

**Equivalent trees planted**

For example, if the lifecycle of a tree is 40 years, the average CO<sub>2</sub> that can be absorbed each year reaches 18.3 kg.

**Formula:**

- CO<sub>2</sub> emissions avoided/Coefficient of equivalent trees planted (18.3)/40 = Equivalent trees planted

**Example:**

The total energy yield of a plant is 739,600 kWh.

Equivalent CO<sub>2</sub> emissions avoided  $\approx$  **351.31 tons**

739600 kWh x 0.475 = 351310 kg



Equivalent trees planted  $\approx$  **480**

351310 kg/18.3/40 = 480



**How do I view the CO<sub>2</sub> emissions avoided and equivalent trees planted of a PV plant?**

- Log in to the FusionSolar Smart PV Management System (Cloud), click the target PV plant, and choose **Monitoring** > **Overview**.
- Log in to the FusionSolar app, tap the target PV plant and then the **Statistics** tab, and scroll to the bottom of the screen.





\* Formula for calculating the coal saved: PV energy yield x Coefficient of coal saved (0.4) = Coal saved (unit: kg)

## 11.2 Environment Parameters

Parameter	Definition	Formula	Remarks
Global irradiation	Total solar radiation energy measured by an environmental monitoring instrument (EMI).	/	An EMI is required.
Average temperature	Average ambient temperature measured by the EMI in the plant.	/	
CO <sub>2</sub> avoided	Amount of CO <sub>2</sub> emitted by burning fossil fuel to produce the same amount of power generated by the plant. 1 kWh of power is equivalent to about 475 g of CO <sub>2</sub> emission (global average value).	Energy yield (kWh) of the plant x per kWh CO <sub>2</sub> emission (0.475)	If the value changes, contact the system administrator to modify the value.
Equivalent trees planted	Number of trees that can absorb the amount of CO <sub>2</sub> avoided by the plant. A tree absorbs 18.3 kg of CO <sub>2</sub> in one year and has a lifespan of 40 years.	CO <sub>2</sub> avoided/CO <sub>2</sub> absorbed by a tree in one year (18.3)/40	
Standard coal saved	Amount of standard coal needed to produce the amount of PV power generated by the plant. 0.4 kg of standard coal is needed to produce 1 kWh of power.	Energy yield (kWh) of the plant x Standard coal needed per kWh (0.4)	

## 11.3 Power Parameters

Parameter	Definition	Formula	Remarks
Total string capacity	Total capacity of PV arrays installed in the PV plant.	Total capacity of the strings connected to all inverters	This parameter is configured during plant creation.
Power per MWp	Power generated per MWp.	Active power/Total string capacity x 1000	-
Theoretical yield (daily/monthly/yearly)	Theoretical amount of power that can be generated by the PV arrays installed in a plant.	Hourly: Hourly global irradiation x String capacity Daily: Daily irradiation x String capacity Monthly: Total theoretical yield of each day in a month Yearly: Total theoretical yield of each month in a year	An EMI is required.
PV output power	Total output power of PV arrays.	PV output power	-
PV yield	Total yield of PV arrays in a given reporting period.	Hourly: PV yield each hour Daily: PV yield each day Monthly: Total yield of each day in a month Yearly: Total yield of each month in a year	-
Inverter yield	Yield of a plant.	Hourly: Inverter output energy each hour Daily: Inverter output energy each day Monthly: Total inverter output energy of each day in a month Yearly: Total inverter output energy of each month in a year	-

Parameter	Definition	Formula	Remarks
Total yield	Total output energy of the PV plant throughout the lifetime.	Total PV energy yield	-
Performance ratio	Ratio of measured output energy to total irradiation received by the plant.	PV energy yield/ Theoretical energy yield	An EMI is required
Specific energy	Ratio of the energy yield to the total string capacity.	PV energy yield/Total PV string capacity	-
Consumption (daily/ monthly/ yearly)	Power consumed by the loads during a given reporting period.	Daily: Amount of power consumed by the loads each day Monthly: Total amount of power consumed by the loads each day in a month Yearly: Total amount of power consumed by the loads each month in a year	-
Fed to grid (daily/ monthly/ yearly)	Amount of power fed to the power grid from the plant in a give reporting period.	Daily: Amount of power fed to the grid from the plant each day Monthly: Total amount of power fed to the grid from the plant each day in a month Yearly: Total amount of power fed to the grid from the plant each month in a year	A power meter is required. Otherwise, the amount of power purchased from or fed to the grid cannot be displayed.
From grid (daily/ monthly/ yearly)	Amount of power purchased from the grid in a given reporting period.	Daily: Amount of power purchased from the grid each day Monthly: Total amount of power purchased from the grid each day in a month Yearly: Total amount of power purchased from the grid each month in a year	

Parameter	Definition	Formula	Remarks
Self-consumption (daily/monthly/yearly)	PV energy consumed by loads and charged to batteries. It includes the amount of PV power consumed directly by loads and the amount of PV power stored in batteries.	Daily: Daily PV yield – Daily feed-in to grid Monthly: Total amount of self-consumed power of each day in a month Yearly: Total amount of self-consumed power of each month in a year	-
From PV (daily/monthly/yearly)	Load consumption from PV. It includes the amount of PV power consumed directly by loads and the amount of PV power discharged from batteries.	Daily: Daily power consumption – Daily supply from grid Monthly: Total amount of self-supplied power of each day in a month Yearly: Total amount of self-supplied power of each day month in a year	-
Total consumption	Load consumption power.	Load consumption power	Supported when loads exist. Not supported when no load exists.

Parameter	Definition	Formula	Remarks
Consumed from PV	Power of PV energy consumed locally.	When feeding to the grid: PV output power - Feed-in power When purchasing power from the grid: PV output power	When the active power of the bi-directional meter is a positive value, the power is the feed-in power. When the active power of the bi-directional meter is a negative value, the power is the power of supply from the grid.
Battery charge/discharge power	Battery charge/discharge power.	Battery charge/discharge power	If the symbol before the power value is +, the battery is charging. If the symbol before the power value is -, the battery is discharging.

Parameter	Definition	Formula	Remarks
PV revenue	Revenues from photovoltaic power generation. It consists of two parts, which are revenue of power fed in to the grid and the saved electricity bills. Electricity prices need to be configured.	Revenue of power fed in to the grid (power fed to the grid x feed-in tariff)+ Saved electricity bills (self-supplied power x electricity price)	If the price unit is inconsistent with the local type, contact the company administrator to change the currency.
Grid Connection Duration	The time period during which the inverter is connected to the power grid.	Daily: daily on-grid duration Monthly: total daily on-grid durations in a month Year: total monthly on-grid durations in a year	The string capacity needs to be configured . If the string capacity is not configured , the calculated on-grid duration will be inaccurate.
Peak Power	Maximum active power of a plant in a statistical period.	Maximum active power of a plant in a statistical period	-
Load Rate	Ratio of the peak power to the string capacity of a plant in a statistical period.	Daily: Daily peak power/String capacity Monthly: Monthly peak power/String capacity Yearly: Yearly peak power/String capacity	The string capacity needs to be configured . The load rate can be calculated only when the string capacity is configured .

Parameter	Definition	Formula	Remarks
Planned Yield	Planned energy yield in a statistical period.	Planned energy yield in a statistical period	Contact the system administrator to configure the planned yield.
Plan Completion Rate	Ratio of the actual feed-in energy to the planned yield of a plant in a statistical period.	Monthly: Monthly feed-in energy/Planned monthly yield Yearly: Yearly feed-in energy/Planned yearly yield	

 NOTE

Unless otherwise specified, the energy yield in this document refers to AC power yield.

## 11.4 Battery Parameters

### Battery parameter settings

Table 11-1 Battery parameters

Parameter Name	Description
Maximum charge power (kW)	Specifies the maximum battery charging power.
Maximum discharge power (kW)	Specifies the maximum battery discharging power.
End-of-charge SOC (%)	Specifies the end-of-charge SOC.
End-of-discharge SOC (%)	Specifies the end-of-discharge SOC. When the battery SOC drops to 0%, charge the batteries in a timely manner. If the batteries are not charged in a timely manner, the battery capacity will attenuate irreversibly. The resulting battery faults are not covered under warranty. You are advised not to set <b>End-of-discharge SOC</b> to 0.
Charge from AC	If <b>Charge from AC</b> is disabled by default, comply with the grid charge requirements stipulated in local laws and regulations when this function is enabled.
AC charge cutoff SOC (%)	Specifies the grid charge cutoff SOC.

**Table 11-2** Battery working modes

Working Mode	Mode Description
No control	No other power scheduling control is performed. The power is automatically controlled by the device.
Maximum self-consumption	<ul style="list-style-type: none"> <li>• This mode applies to areas where the electricity price is high, or areas where the feed-in tariff (FIT) subsidy is low or unavailable.</li> <li>• PV energy is preferentially supplied to loads, and the surplus energy is used to charge the batteries. If the batteries are fully charged or are being charged at full power, the surplus energy is fed to the grid. When PV energy is insufficient or no PV energy can be generated at night, the batteries discharge energy to loads. This improves the self-consumption rate and energy self-sufficiency rate, and reduces electricity costs. The grid cannot charge the batteries.</li> </ul>
Fully fed to grid	<ul style="list-style-type: none"> <li>• This mode applies only to distributed scenarios.</li> <li>• This mode maximizes the PV energy fed to the grid. When the generated PV energy in the daytime is greater than the maximum output capability of the inverter, the surplus energy is used to charge batteries. When the generated PV energy is less than the maximum output capability of the inverter, the batteries discharge energy to the inverter to maximize the energy fed from the inverter to the grid. The grid cannot charge the batteries.</li> </ul>

Working Mode	Mode Description
TOU	<ul style="list-style-type: none"> <li>• This mode applies to the PV+ESS scenario and ESS-only scenario where peak to valley electricity prices are different and power meters are available.</li> <li>• You can manually set the charge and discharge time segments. For example, if you set the low electricity price period at night as the charge time, the system charges the batteries at the maximum power during the charge time. If you set the high electricity price period as the discharge time, batteries can discharge only during the discharge time based on the actual load power, reducing electricity costs.</li> <li>• Click <b>Add</b> to set the charge and discharge time segments. A maximum of 14 time segments can be set. During the charge time, the grid can charge the batteries. During the discharge time, the batteries can supply power to the loads. In other time segments, the batteries do not discharge. The PV system and grid supply power to loads, and the PV system can charge the batteries. (In grid-tied/off-grid mode, if the grid fails, the batteries can discharge power at any time.)</li> <li>• In some countries, the grid is not allowed to charge batteries. In such case, this mode cannot be used.</li> </ul>
<b>Third-party dispatch</b>	<ul style="list-style-type: none"> <li>• Only a third-party platform controls battery charge and discharge.</li> <li>• During charging, the PV power is preferentially used for charging batteries.</li> <li>• During discharging, batteries are preferentially discharged, and surplus PV power is discarded.</li> </ul>
Dispatching charge and discharge	<ul style="list-style-type: none"> <li>• This mode applies to utility-scale plant scheduling scenarios where a third-party controller delivers active power scheduling commands.</li> <li>• The purpose of scheduled discharge is to meet the active power scheduling target value at the grid access point. PV energy is preferred. If the generated PV energy is insufficient, the batteries discharge and the energy is fed to the grid based on the active power scheduling target value. If the generated PV energy is sufficient, the energy is fed to the grid based on the active power scheduling target value, and the surplus PV energy is used to charge the batteries.</li> <li>• The purpose of scheduled charge is to meet the active power scheduling target value at the grid access point. If the battery charge power is insufficient or the Smart PCS limits the power, the grid charges the batteries with the maximum capability. If the batteries are not fully charged when the scheduling target value is met, the PV power is used to charge the batteries.</li> </ul>

Working Mode	Mode Description
TOU (fixed power)	<ul style="list-style-type: none"> <li>● This mode applies the PV+ESS scenario and ESS-only scenario where peak to valley electricity prices are different and power meters are unavailable.</li> <li>● You can manually set the charge and discharge time segments. For example, if you set the low electricity price period at night as the charge time, the system charges the batteries at the fixed power during the charge time. If you set the high electricity price period as the discharge time, batteries can discharge only during the discharge time at the fixed power, reducing electricity costs.</li> <li>● Click <b>Add</b> to set the charge and discharge time segments. A maximum of 14 time segments can be set. During the charge time, the grid can charge the batteries. During the discharge time, the batteries can supply power to the loads. In other time segments, the batteries do not discharge and are not charged.</li> <li>● In some countries, the grid is not allowed to charge batteries. In such case, this mode cannot be used.</li> </ul>
Fixed charge/ discharge	In this mode, the batteries are charged or discharge in the time segments that are set. A maximum of 10 time segments can be added.
Time of use electricity price	In this mode, the batteries discharge when the electricity price is high and the batteries are charged when the electricity price is low. A maximum of 10 time segments can be added.

**Table 11-3** Running parameters in each battery working mode

Working Mode	Parameter	Description
TOU	Redundant PV energy priority	<ul style="list-style-type: none"> <li>• <b>Charge preference:</b> When the PV power is greater than the load power, the surplus PV energy is used to charge the batteries. After the maximum charge power is reached or the batteries are fully charged, the surplus PV energy is fed to the grid.</li> <li>• <b>Fed-to-grid preference:</b> When the PV power is greater than the load power, the surplus PV energy is preferentially fed to the grid. When the maximum output power of the device is reached, the surplus energy is used to charge the batteries. This setting is applicable to the scenario where the FIT is higher than the electricity price. The grid cannot charge the batteries.</li> </ul>
	Allowed AC charge power	Specifies the maximum power at which the grid charges the batteries.
	Start Time	Specifies the start time and end time of charge and discharge. A maximum of 14 time segments can be set. You can set a cycle by week by clicking the buttons corresponding to <b>Mon.</b> through <b>Sun.</b> in the <b>Repeat</b> box.
	End Time	
	Charge/Discharge	
	Repeat	
TOU (fixed power)	Start Time	Specifies the start time, end time, and power of charge and discharge. A maximum of 14 time segments can be set. You can set a cycle by week by clicking the buttons corresponding to <b>Mon.</b> through <b>Sun.</b> in the <b>Repeat</b> box.
	End Time	
	Charge/Discharge	
	Fixed Charge/Discharge Power	
	Repeat	
Fixed charge/discharge	Start Time	Specifies the start time, end time, and power of fixed charge and discharge. A maximum of 10 time segments can be set.
	End Time	
	Charge/Discharge power	
Time of use electricity price	Time-of-use price enable	The time-of-use electricity price is disabled by default. After it is enabled, you can set the time-of-use electricity price.

Working Mode	Parameter	Description
	Start Time	Specifies the start time, end time, and electricity price. This parameter is displayed when <b>Time-of-use price enable</b> is set to <b>Enable</b> . A maximum of 10 time segments can be set.
	End Time	
	Time-of-use	

**Table 11-4** Forced charge/discharge parameters

Parameter Name	Description
Charge/Discharge	Forced charge/discharge operation, which can be <b>Charge</b> , <b>Discharge</b> , or <b>Stop</b> .
Forced charge power/Forced discharge power	Specifies the forced charge/discharge power.
Setting mode	To enter the forced charge/discharge mode, set <b>Duration</b> or <b>Energy</b> .
Target SOC (%)	Specifies the target SOC for forced charge/discharge. When the SOC reaches this value, the forced charge/discharge stops automatically. This parameter is displayed when <b>Setting mode</b> is set to <b>Energy</b> .
Forced charge/discharge period (min)	Specifies the forced charge/discharge duration.
Remaining charge/discharge time (min)	Displays the remaining charge/discharge time. This parameter cannot be set.
Charged energy/Discharged energy (kWh)	Displays the charged and discharged energy. This parameter cannot be set.

## Capacity Control Parameters (Peak Shaving)

The Peak Shaving function can reduce the maximum peak power obtained from the grid during peak hours by configuring the power supply power in self-use mode or TOU mode, thereby reducing power consumption costs.

Parameter	Description	Range
Peak Shaving	<ol style="list-style-type: none"> <li>Before enabling <b>Peak Shaving</b>, set <b>Charge from AC</b> to <b>Enable</b>.</li> <li>Before disabling <b>Charge from AC</b>, set <b>Peak Shaving</b> to <b>Disable</b>.</li> </ol>	<ul style="list-style-type: none"> <li>Disable</li> <li>Active Power Limit</li> </ul>
Backup power SOC for peak shaving (%)	The value of this parameter affects the peak shaving capability. A larger value indicates stronger peak shaving capability.	[0.0, 100.0] Backup power SOC for peak shaving > Backup power SOC (when BackUp is enabled) > End-of-discharge SOC
Start Time	<ul style="list-style-type: none"> <li>Set the peak power range based on the start time and end time. The peak power is configured based on electricity prices in different time segments. You are advised to set the peak power to a low value when the electricity price is high.</li> <li>A maximum of 14 time segments can be set.</li> <li>You can set a cycle by week by clicking the buttons corresponding to <b>Mon.</b> through <b>Sun.</b> in the <b>Repeat</b> box.</li> </ul>	-
End Time		-
Peak Power (kW)		[0.000, 1000.000]
Repeat		-

 **NOTE**

The peak shaving function is unavailable when the battery working mode is set to **Fully fed to grid**.

## 11.5 Domain Name List of Management Systems

 **NOTE**

The list is subject to change.

**Table 11-5** Domain names of management systems

Domain Name	Data Type	Scenario
intl.fusionsolar.huawei.com	Public IP address	Global domain name of FusionSolar SmartPVMS <b>NOTE</b> Compatible with the original domain name <b>cn.fusionsolar.huawei.com</b> in Chinese mainland
au7.fusionsolar.huawei.com	Public IP address	Domain name of Australia single-node server
eu5.fusionsolar.huawei.com	Public IP address	Domain name of FusionSolar SmartPVMS in Europe
intlobt.fusionsolar.huawei.com	Public IP address	Domain name of FusionSolar SmartPVMS in Europe
jp5.fusionsolar.huawei.com	Public IP address	Domain name of FusionSolar SmartPVMS in Japan
la5.fusionsolar.huawei.com	Public IP address	Domain name of FusionSolar SmartPVMS in Latin America
kr5.fusionsolar.huawei.com	Public IP address	Domain name of FusionSolar SmartPVMS in South Korea
sg5.fusionsolar.huawei.com	Public IP address	Domain name of FusionSolar SmartPVMS in Asia Pacific and Australia
region01eu5.fusionsolar.huawei.com	Public IP address	Server domain name of FusionSolar SmartPVMS in European cluster 1
region02eu5.fusionsolar.huawei.com	Public IP address	Server domain name of FusionSolar SmartPVMS in European cluster 2
region03eu5.fusionsolar.huawei.com	Public IP address	Server domain name of FusionSolar SmartPVMS in European cluster 3
region04eu5.fusionsolar.huawei.com	Public IP address	Server domain name of FusionSolar SmartPVMS in European cluster 4

Domain Name	Data Type	Scenario
neteco.alsoenergy.com	Public IP address	Domain name of partner's management system
re-ene.kyuden.co.jp	Public IP address	Domain name of the remote output control server of Kyushu Electric Power Company
re-ene.yonden.co.jp	Public IP address	Domain name of the remote output control server of Shikoku Electric Power Company
au1.fusionsolar.huawei.com	Public IP address	Domain name of FusionSolar SmartPVMS in Australia
br1.fusionsolar.huawei.com	Public IP address	Domain name of FusionSolar SmartPVMS in Brazil
huawei.devicedataacquisition.com	Public IP address	Domain name of the third-party network management system Locus dedicated for the United States
pvms01cn.fusionsolar.huawei.com pvmspro01cn.fusionsolar.huawei.com	Public IP address	Domain names for whole-county rollout projects in Chinese mainland

## 11.6 Public URLs

**Table 11-6** Public URLs of the SUN2000 app

URL	Description
<a href="https://solar.huawei.com/~media/Solar/Device/invert.xml">https://solar.huawei.com/~media/Solar/Device/invert.xml</a>	The mobile phone automatically detects software updates when connected to the Internet. If the device upgrade package or grid code is updated, a message is displayed to prompt users to download the upgrade package or grid code. After the distributed inverter is connected, the system prompts you to install the upgrade package.

URL	Description
<a href="https://solar.huawei.com/~media/Solar/Device/DeviceUpgrade.zip">https://solar.huawei.com/~media/Solar/Device/DeviceUpgrade.zip</a>	Download the device upgrade package.
<a href="https://solar.huawei.com/~media/Solar/Device/InverterGridCode.zip">https://solar.huawei.com/~media/Solar/Device/InverterGridCode.zip</a>	Download the grid code update package.
<a href="https://support.huawei.com/enterprise/en/doc/EDOC1100054980">https://support.huawei.com/enterprise/en/doc/EDOC1100054980</a>	View the app quick guide.
<a href="https://solar.huawei.com/na/appversion">https://solar.huawei.com/na/appversion</a>	The mobile phone automatically obtaining app version information when connected to the Internet.

**Table 11-7** Public URLs of the FusionSolar app

URL	Description
<a href="https://support.huawei.com/enterprise/">https://support.huawei.com/enterprise/</a>	View the app guide.
<a href="https://info.support.huawei.com/">https://info.support.huawei.com/</a>	View the app guide.
<a href="http://digitalpower.huawei.com">digitalpower.huawei.com</a>	Access digital services.
<a href="http://forum.huawei.com">forum.huawei.com</a>	Access other services in the intelligent customer service.
*.apple.com	Official website of Apple. The iOS version of the FusionSolar app needs to connect to this website for upgrade.
*.pinnettech.com	Official website of Pinnet Technologies. The FusionSolar app needs to connect to this website for upgrade.
<a href="https://solar.huawei.com">https://solar.huawei.com</a>	FusionSolar official website
<a href="mailto:eu_inverter_support@huawei.com">eu_inverter_support@huawei.com</a>	FusionSolar service email
<a href="http://baidumap://map/marker">baidumap://map/marker</a>	Baidu Maps
<a href="http://androidamap://viewMap">androidamap://viewMap</a>	Amap
<a href="http://maps.google.com">http://maps.google.com</a>	Google Maps
<a href="http://qqmap://map/marker">qqmap://map/marker</a>	Tencent Maps
<a href="https://community.solar.huawei.com/">https://community.solar.huawei.com/</a>	Visit the installer community.